

DATI TECNICI

TECHNICAL DATA

Pewag Winner 200 chains meet the requirements of ASTM A973/ A 973M-01 and of EN 818-2 but with higher load capacity, and 2006/42/EC Machinery Directive. Lifting components are manufactured according to EN 1677, with increased load capacity.

- Breaking elongation: **min 20%**
- Stress at load capacity limit: **250 N/mm²**
- Test stress: **625 N/mm²** - corresponds to 2,5 times the load capacity
- Breaking stress: **1000 N/mm²** - corresponds to 4 times the load capacity
- Bending according to EN 818-2: **0.8 x d**
- **Admissible operating temperature: max 200 °C.**
For use at temperatures up to 380 °C, Winner 400 chain is available.

Le catene Pewag Winner 200 sono prodotte in accordo a ASTM A973/ A973M-01 e a EN 818-2 ma con portate superiori e alla Direttiva Macchine 2006/42/CE. I componenti sono prodotti in accordo a EN 1677, con valori di portata superiori.

- Allungamento a rottura: **min 20%**
- Sollecitazione al carico di lavoro: **250 N/mm²**
- Sollecitazione al carico di prova: **625 N/mm²** - 2,5 volte la portata nominale
- Sollecitazione alla rottura: **1000 N/mm²** - 4 volte la portata nominale
- Piegatura in accordo a EN 818-2: **0,8 x diametro catena**
- **Massima temperatura ammissibile 200°C.**
Per impiego in presenza di temperature fino a 380°C, è disponibile la catena Winner 400.

MARCATURE

MARKING

Pewag Winner chains are marked with the manufacturer name or symbol, the quality grade (10) and the production lot number.

All the slings are delivered complete with steel identification tag and declaration of conformity.

Le catene Pewag-Winner sono marcate con il simbolo di identificazione del produttore, il grado qualitativo (10) e il numero di identificazione del lotto di produzione.

Tutti i tiranti vengono consegnati completi di targhetta metallica di identificazione e dichiarazione di conformità CE.

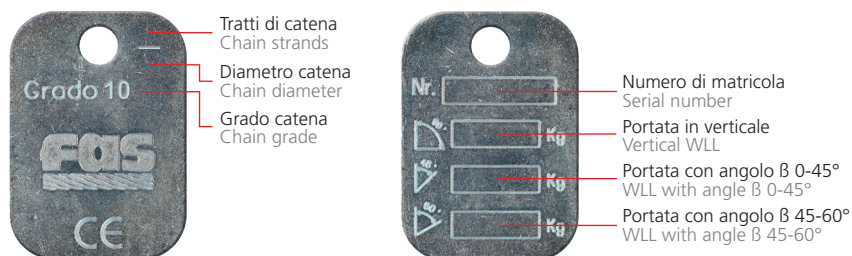

25% IN PIÙ DI PORTATA / 30% DI PESO IN MENO

25% HIGHER LOAD CAPACITY / 30% WEIGHT SAVED

The capacity increased by 25% compared to the corresponding Grade 8 chains allows to assemble chains of smaller diameter, therefore the sling is lighter and easier to handle.

La portata superiore del 25% rispetto alle corrispondenti catene Grado 8 permette di utilizzare catene di diametro inferiore e quindi l'imbragatura risulta più leggera e maneggevole.

Confronto tra le portate di imbragature G8 e G10

G8 and G10 chain slings load capacities comparison

Portata Load capacity	Braca a 2 bracci G8 2 legs sling G8	Braca a 2 bracci G10 2 legs sling G10
Kg	Ø mm	Ø mm
3550	10	8
5600	13	10
9500	16	13

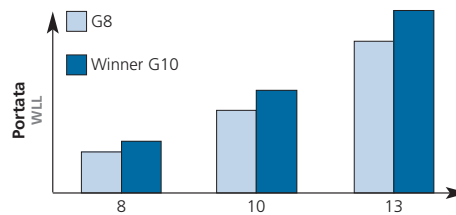

Confronto tra i pesi di imbragature G8 e G10

G8 and G10 chain slings weights comparison

Portata Load capacity	Peso braca a 2 bracci L=3m - Grado 8 Weight of a 2 legs chain sling L=3m - Grade 8	Peso braca a 2 bracci L=3m - Grado 10 Weight of a 2 legs chain sling L=3m - Grade 10	Differenza di peso Weight reduction
Kg	Kg	Kg	%
3550	16,2	11,0	32
5600	27,6	17,6	36
9500	42,2	29,6	30

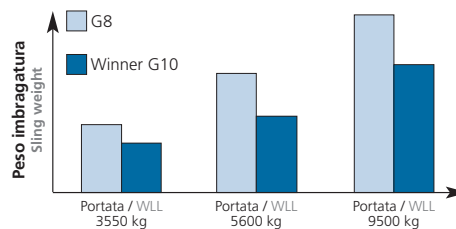

30% circa più leggera l'imbragatura G10.
Approx 30% weight saved with G10 chain sling.

LONGER SERVICE LIFE

Extended service life due to higher wear resistance.

ATTRACTIVE PRICE

Attractive price-performance ratio thanks to the small price difference compared to G8 and, for many load ranges, one dimension smaller than grade 8 slings.

WIDE RANGE AND INTERCHANGEABILITY

- Broad range of components in special grade 10 quality, for 11 chain dimensions;
- All components are interchangeable with the range Pewag Grade 8. In this case the capacity of the sling is determined by the component in grade 8.

ENVIRONMENTALLY FRIENDLY CHAIN

- Pewag Grade 10 chain take care of the environment: energy consumption during production is reduced, less material is used and therefore less material to be recycled.

LUNGA DURATA

Basso grado di usura dovuto all'alta resistenza del materiale.

OTTIMO RAPPORTO PREZZO - PRESTAZIONI

La limitata differenza di prezzo con il grado 8 e la portata superiore che spesso consente l'utilizzo di una misura di catena e accessori inferiore rendono il sistema grado 10 Pewag estremamente interessante anche dal punto di vista economico.

AMPIA GAMMA E INTERCAMBIABILITÀ

- Una vasta gamma di accessori per 11 diametri di catena;
- Tutti i componenti sono intercambiabili con la gamma Pewag Grado 8. La portata del tirante è determinata dal componente di Grado 8

RISPETTO PER L'AMBIENTE

- La catena Pewag Grado 10 rispetta l'ambiente: è ridotto il consumo energetico durante la produzione, viene utilizzato meno materiale e quindi è minore il riciclo.

LIMITAZIONI ALL'USO DELLE BRACHE DEMANDING CONDITIONS

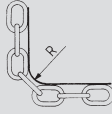
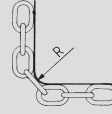
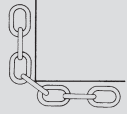
Temperatura Temperature	-40°C ÷ 200°C	200°C ÷ 300°C	300°C ÷ 400°C
Fattore di carico Load factor	1	Non ammissibile. Not permissible.	
Distribuzione asimmetrica del carico Asymmetric load distribution	<p>La portata della braca deve essere diminuita di un braccio. Nel caso di brache a 3-4 bracci, la portata sarà quella di una braca a 2 bracci della catena corrispondente. Nel caso di brache a 2 bracci, la portata sarà quella della braca ad un braccio. Se la distribuzione del carico non è chiara, considerare sempre la portata della braca ad 1 braccio.</p> <p>The capacity of the sling should be decreased to a leg. In the case of 3 - 4 legs slings, the capacity will be as a 2 legs sling of the corresponding chain. In the case of 2 legs slings, the capacity will be of 1 leg sling. If the distribution of the load is not clear, always consider the capacity of 1 leg sling.</p>		
Sollevamento con catena a contatto con spigoli Edge load	 $R > 2 \times \varnothing$ catena/chain	 $R > \varnothing$ catena/chain	 $R < \varnothing$ catena/chain
Fattore di carico Load factor	1	0,7	0,5
Shock	Shock leggero Slight shock	Shock medio Medium shock	Shock pesante Heavy shock
Fattore di carico Load factor	1	0,7	Non ammissibile Not permissible

Quando la catena viene avvolta su un perno o intorno al carico, il diametro dello stesso deve essere almeno 3 volte il passo della catena. In caso contrario, la portata della braca deve essere ridotta del 50%.

When lifting with chains on lugs or on round loads, it is recommended to use a lug diameter of at least 3 x the pitch of the chain. If this is not a case, the working load limit must be reduced by 50%.



PORTATA DELLE IMBRAGATURE LOAD CAPACITIES

Coefficiente di sicurezza 4 Safety factor 4	1 braccio 1 leg		2 bracci 2 legs				3 e 4 bracci 3 and 4 legs		3 e 4 bracci con distributore di carico 3 and 4 legs with load distributor		Anello continuo Endless chain sling	Imbragatura a canestro Loop chains				
Angolo β Angle β	-	-	0°-45°	45°-60°	0°-45°	45°-60°	0°-45°	45°-60°	0°-45°	45°-60°	-	0°-45°	45°-60°	0°-45°	45°-60°	
Fattore di carico Load factor	1	0,8	1,4	1	1,12	0,8	2,1	1,5	2,8	2	1,6	1,4	1	2,1	1,5	
Catena tipo Chain type	d	Portata Kg WLL Kg														
WIN 5 G10	5	1000	800	1400	1000	1120	800	2000	1500	2800	2000	1600	1400	1000	2000	1500
G8	5	800	640	1120	800	900	640	1600	1180	2240	1600	1250	1120	800	1600	1180
WIN 6 G10	6	1400	1120	2000	1400	1600	1120	3000	2120	4000	2800	2240	2000	1400	3000	2120
G8	6	1120	900	1600	1120	1250	900	2360	1700	3150	2240	1800	1600	1120	2360	1700
WIN 7 G10	7	1900	1500	2650	1900	2120	1500	4000	2800	5300	3750	3000	2650	1900	4000	2800
G8	7	1500	1200	2120	1500	1700	1200	3150	2240	4000	3000	2500	2120	1500	3150	2240
WIN 8 G10	8	2500	2000	3550	2500	2800	2000	5300	3750	7100	5000	4000	3550	2500	5300	3750
G8	8	2000	1600	2800	2000	2240	1600	4250	3000	5600	4000	3150	2800	2000	4250	3000
WIN 10 G10	10	4000	3150	5600	4000	4250	3150	8000	6000	11200	8000	6300	5600	4000	8000	6000
G8	10	3150	2500	4250	3150	3550	2500	6700	4750	8500	6300	5000	4250	3150	6700	4750
WIN 13 G10	13	6700	5300	9500	6700	7500	5300	14000	10000	19000	13200	10600	9500	6700	14000	10000
G8	13	5300	4250	7500	5300	5900	4250	11200	8000	14000	10600	8500	7500	5300	11200	8000
WIN 16 G10	16	10000	8000	14000	10000	11200	8000	21200	15000	28000	20000	16000	14000	10000	21200	15000
G8	16	8000	6300	11200	8000	9000	6300	17000	11800	22400	16000	12500	11200	8000	17000	11800
WIN 19 G10	19	14000	11200	20000	14000	16000	11200	30000	21200	-	-	22400	20000	14000	30000	21200
G8	19	11200	8950	16000	11200	12500	8950	23600	17000	-	-	18000	16000	11200	23600	17000
WIN 22 G10	22	19000	15000	26500	19000	21200	15000	40000	28000	-	-	30000	26500	19000	40000	28000
G8	22	15000	12000	21200	15000	17000	12000	31500	22400	-	-	23600	21200	15000	31500	22400
WIN 26 G10	26	26500	21200	37500	26500	30000	21200	56000	40000	-	-	42500	37500	26500	56000	40000
G8	26	21200	16950	30000	21200	23700	16950	45000	31500	-	-	33500	30000	21200	45000	31500
WIN 32 G10	32	40000	31500	56000	40000	45000	31500	85000	60000	-	-	63000	56000	40000	85000	60000
G8	32	31500	25200	45000	31500	35200	25200	67000	47500	-	-	50000	45000	31500	67000	47500

Viene evidenziata la differenza di portata tra le catene WINNER GRADO 10 e le catene GRADO 8.
The table shows the different load capacities of Winner G10 sling chains compared to G8 chains.

Se l'imbragatura è sottoposta a temperature estreme, carichi asimmetrici o a spigoli vivi, è necessario ridurre i valori indicati in tabella, utilizzando i fattori riportati nella pagina accanto.

If the chain slings are used in severe conditions, as high temperatures, asymmetric load distribution or sharp edges, the maximum load capacity values must be reduced by the load factor below.



CARATTERISTICHE SPECIFICATION

Pewag Winner chain slings can be supplied assembled with connecting links or with clevis accessories. The usual tolerance of length L is +2 chain pitches.

ORDER TEXT

Specific information related to the capacity required, lifting points, uneven distribution of the load in case of more chain legs, angle between the legs of the sling, abnormal temperatures.

Example of order

Pewag Winner - 13 mm - double-leg chain sling with master link and eye hook - length 1.600 mm
Cod. 2AH 13 L= 1.600 mm.

I tiranti Pewag Winner possono essere forniti con accessori di tipo a occhio, con maglie di giunzione o con accessori di tipo a perno.
La normale tolleranza della lunghezza L è pari a 2 passi di catena.

DATI NECESSARI PER L'ORDINE

Informazioni inerenti la portata totale richiesta, punti di ancoraggio, distribuzione non uniforme del carico nel caso di tiranti a più bracci, ampiezza dell'angolo tra i bracci di catena, temperature anormali.

Esempio di ordine

Tirante di catena Pewag Winner d. 13 mm a 2 bracci con campanella e 2 ganci ad occhio alle estremità lunghezza L=1600 mm.
Cod. del tirante: 2AH 13 L=1600 mm.



I codici in **nero** indicano accessori terminali a occhio.
Black codes mean eye type bottom hooks

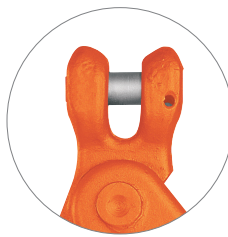

I codici in **blu** indicano accessori terminali a perno.
Blue codes mean clevis type bottom hooks

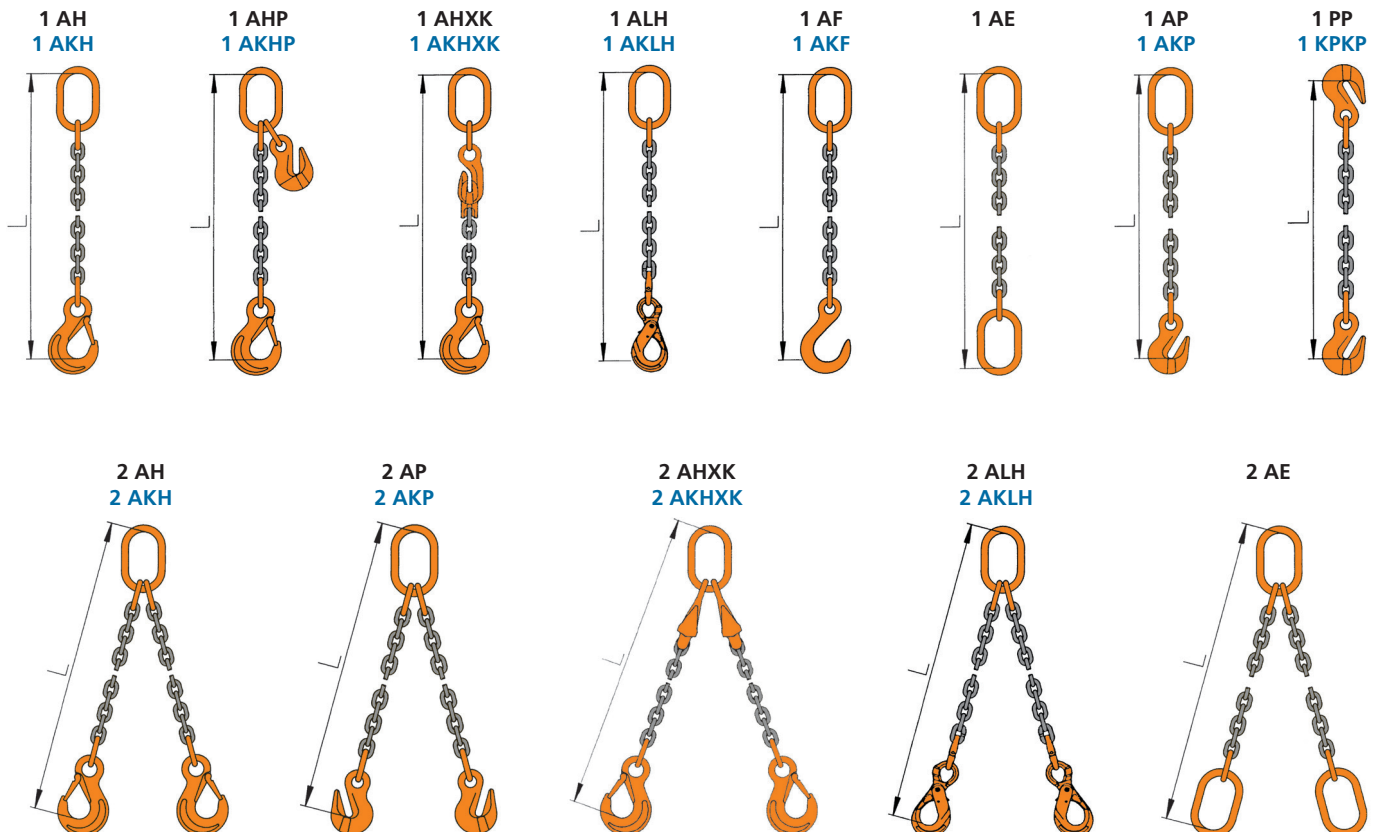

**Catene e accessori
Winner - Grado 10**

Winner chain and
accessory system in G10

BRACHE DI CATENA STANDARD
STANDARD CHAIN SLINGS

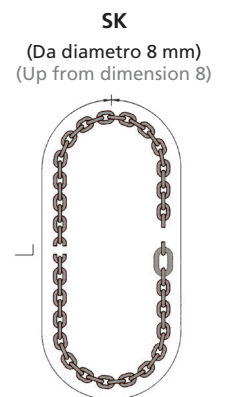
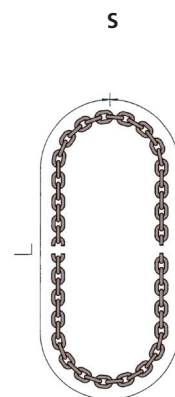
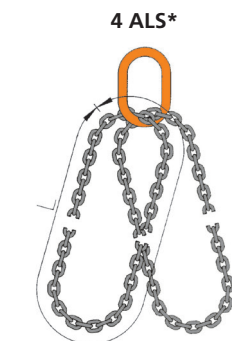
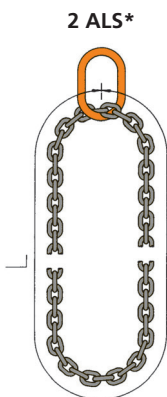
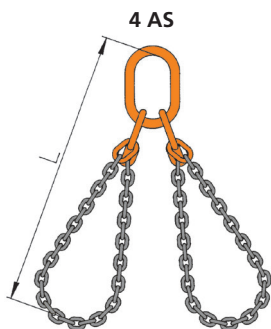
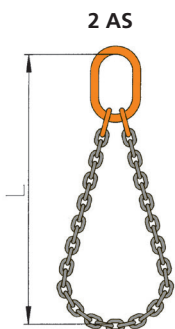
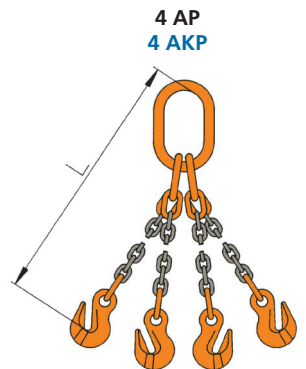
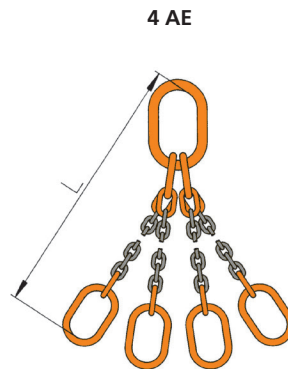
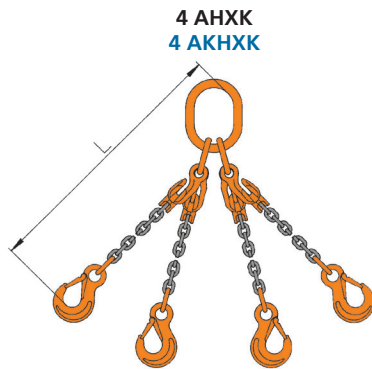
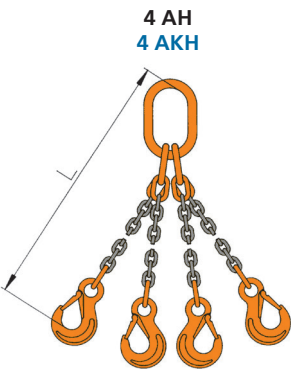
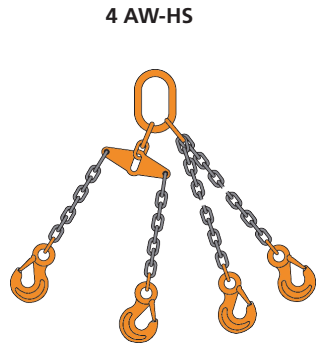
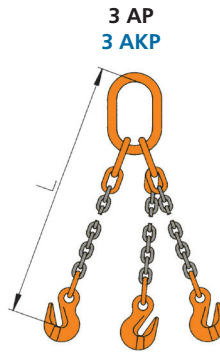
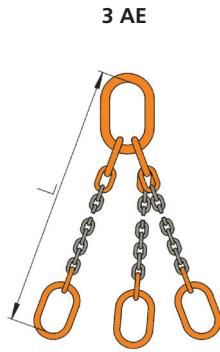
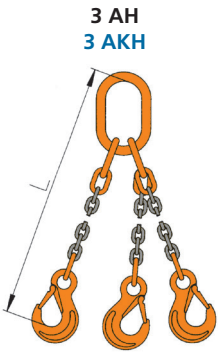
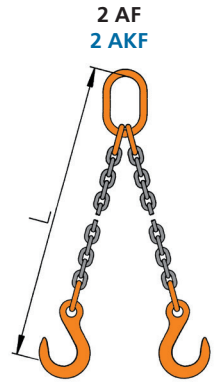
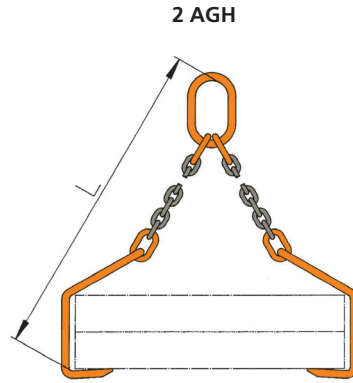
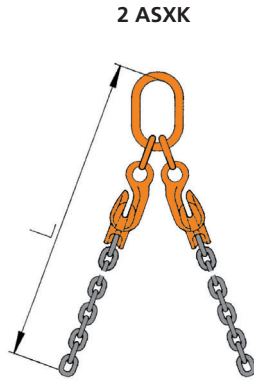
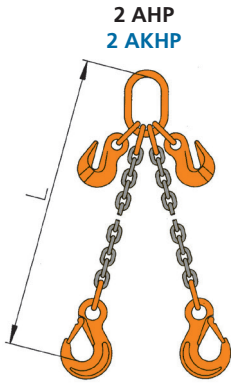
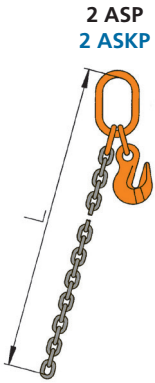

* Riduzione di portata
* Load reduction

Catene e accessori Winner - Grado 10

Winner chain and
accessory system in G10

Catena G10 tipo WIN

G10 chain WIN type

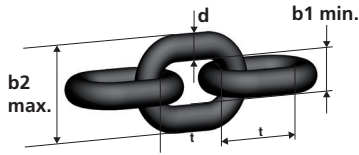

Le catene Pewag Winner possono essere utilizzate fino a temperatura max 200°C.

Per impiego in presenza di temperature fino a 380°C, è disponibile il programma Winner 400.

The maximum working temperature of the Winner chain is 200°C.

For use at higher temperature up to 380°C, is available the Winner 400 chain.

Tipo Type	Diametro nominale Nominal diameter	Lunghezza standard disponibile Standard delivery length	Passo Pitch	Larghezza interna b1 min. Inside width b1 min.	Larghezza esterna b2 max. Outside width b2 max.	Portata WLL	Carico di rottura Breaking force	Peso Weight
	d mm	m	t mm	mm	mm	Kg	kN	Kg/m
WIN 5	5	100 / 50	16	8	19	1000	39,3	0,61
WIN 6	6	200 / 50	18	9	22	1400	56,5	0,96
WIN 7	7	300 / 50	21	10	25	1900	77	1,2
WIN 8	8	250 / 50	24	11	29	2500	101	1,57
WIN 10	10	150 / 50	30	14	36	4000	157	2,46
WIN 13	13	100 / 50	39	18	47	6700	265	4,18
WIN 16	16	100 / 25	48	22	58	10000	402	6,28
WIN 19	19	50 / 25	57	27	69	14000	567	8,9
WIN 22	22	50 / 25	66	30	79	19000	760	11,88
WIN 26	26	25	78	35	94	26500	1060	16,18
WIN 32	32	20	96	43	115	40000	1610	24,1

Campanella semplice AW

AW Master link

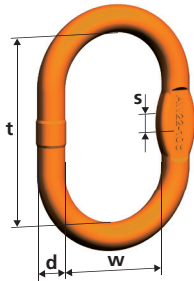

Tipo Type	Portata 0°-45° WLL 0°-45° Kg	Idonea per ganci DIN 15401 Can be used up to single hook acc. to DIN 15401 n°	Dimensioni Dimensions				Peso Weight Kg	Campanella per catena Ø Master link for chain Ø	
			d mm	t mm	w mm	s mm		1 br. 1 leg	2 br. 2 legs
AW 10	1400	1,6	10	80	50	10	0,14	5	5
AW 13	2300	2,5	13	110	60	10	0,34	6+7	6
AW 16	3500	2,5	16	110	60	14	0,53	8	7
AW 18	5000	5	18	135	75	14	0,86	10	8
AW 22	7600	6	23	160	90	17	1,60	13	10
AW 26	10000	8	27	180	100	20	2,46	16	13
AW 32	14000	10	33	200	110	29	4,14	19	16
AW 36	25100	16	36	260	140	-	6,22	22	19
AW 45	30800	25	45	340	180	-	12,82	26	22
AW 50	40000	32	50	350	190	-	16,55	32	26
AW 56	64000	32	60	400	200	-	27,01	-	32
AW 72	85000	50	70	460	250	-	45,00	-	-

Campanella maggiorata MW

MW Enlarged master link

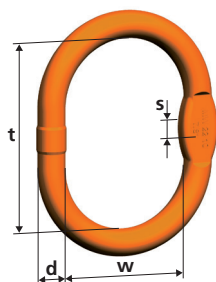

Tipo Type	Portata 0°-45° WLL 0°-45° Kg	Idonea per ganci DIN 15401 Can be used up to single hook acc. to DIN 15401 n°	Dimensioni Dimensions				Peso Weight Kg	Campanella per catena Ø Master link for chain Ø	
			d mm	t mm	w mm	s mm		1 br. 1 leg	2 br. 2 legs
MW 10	1400	2,5	11	90	65	10	0,22	5	5
MW 13	2300	4	14	120	70	10	0,44	6+7	6
MW 16	3200	5	16	140	80	13	0,67	8	7
MW 18	4200	6	19	160	95	14	1,09	10	8
MW 22	6700	10	23	170	105	17	1,69	13	10
MW 26	10100	10	27	190	110	20	2,65	16	13
MW 32	16000	12	33	230	130	26	4,78	19	16
MW 36	21200	20	38	275	150	29	7,48	22	19
MW 56	40000	50	56	350	250	46	21,98	32	26

Catene e accessori Winner - Grado 10

Winner chain and
accessory system in G10

Campanella tripla VW

VW Master link assembly

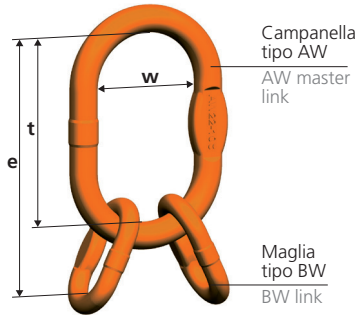

Tipo Type	Assemblaggio Consisting of	Portata 0°-45° WLL 0°-45° Kg	Idonea per ganci DIN 15401 Can be used up to single hook acc. to DIN 15401 n°	Dimensioni Dimensions			Peso Weight Kg
				e mm	t mm	w mm	
VW 5	AW 13 + 2 BW 10	2300	2,5	154	110	60	0,52
VW 6	AW 18 + 2 BW 13	4200	5	189	135	75	1,26
VW 7-8	AW 22 + 2 BW 16	7600	6	230	160	90	2,32
VW 10	AW 26 + 2 BW 20	9600	8	265	180	100	3,68
VW 13	AW 32 + 2 BW 22	14000	10	315	200	110	6,46
VW 16	AW 36 + 2 BW 26	21200	16	400	260	140	10,06
VW 19-20	AW 50 + 2 BW 32	34100	32	500	350	190	22,87
VW 22	AW 50 + 2 BW 36	40000	32	520	350	190	24,79
VW 26	AW 56 + 2 BW 45	56000	32	570	400	200	41,31
VW 32	AW 72 + 2 BW 50	85000	50	660	460	250	66,60

Campanella tripla maggiorata VMW

VMW Enlarged master link assembly

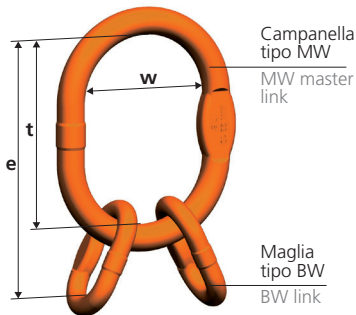

Tipo Type	Assemblaggio Consisting of	Portata 0°-45° WLL 0°-45° Kg	Idonea per ganci DIN 15401 Can be used up to single hook acc. to DIN 15401 n°	Dimensioni Dimensions			Peso Weight Kg
				e mm	t mm	w mm	
VMW 6	MW 18 + 2 BW 13	4200	6	214	160	95	1,43
VMW 7-8	MW 22 + 2 BW 16	6600	10	230	170	105	2,41
VMW 10	MW 26 + 2 BW 20	10100	10	275	190	110	4,01
VMW 13	MW 32 + 2 BW 22	15700	12	345	230	130	6,90
VMW 16	MW 36 + 2 BW 26	21200	20	415	275	150	11,12
VMW 19-20	MW 56 + 2 BW 32	34100	50	500	350	250	28,08
VMW 22	MW 56 + 2 BW 36	40000	50	520	350	250	30,6

Maglia di transizione BW

BW Transition link

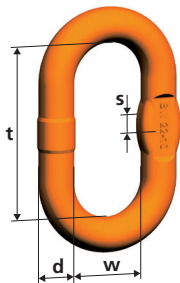

Tipo Type	Portata 0°-45° WLL 0°-45° Kg	Dimensioni Dimensions				Peso Weight Kg	Maglia per catena Ø Transition link for chain Ø 1-2 br. 1-2 legs
		d mm	t mm	w mm	s mm		
BW 7	1000	7	36	16	7	0,03	5
BW 8*	1400	8	36	16	-	0,03	6
BW 9	1900	9	44	20	-	0,07	7
BW 10	2500	10	44	20	-	0,09	8
BW 13	4000	13	54	25	10	0,17	10
BW 16	6700	17	70	34	14	0,36	13
BW 20	10000	20	85	40	14	0,68	16
BW 22	12500	23	115	50	17	1,16	-
BW 23*	14000	23	115	45	17	1,15	19
BW 26	16200	27	140	65	20	1,92	-
BW 27*	19000	27	140	55	20	1,92	22
BW 32	26500	33	150	70	26	3,16	26
BW 36	31000	36	170	75	-	4,12	-
BW 40	40400	40	170	80	-	5,37	32
BW 45	42400	45	170	80	-	7,15	-
BW 50	64000	50	200	100	-	10,8	-

* Solo con brache saldate.

* Only in welded slings.

Campanella maggiorata VLW

VLW Oversize master link assembly

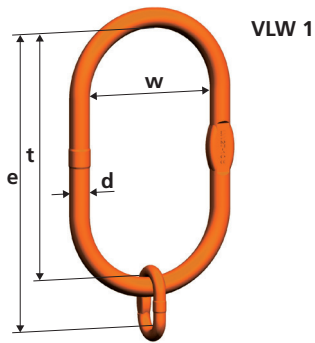

VLW 1

Tipo Type	Assemblaggio Consisting of	Portata WLL Kg	Idonea per ganci DIN 15401 Can be used up to single hook acc. to DIN 15401 n°	Dimensioni Dimensions				Peso Weight Kg
				d mm	e mm	t mm	w mm	
VLW 1-6/7/8	LW 22 + BW 13	2500	25	22	394	340	180	3,4
VLW 1-10	LW 27 + BW 16	4000	25	27	410	340	180	4,8
VLW 1-13	LW 27	6700	25	27	340	340	180	4,4
VLW 1-16	LW 32	10000	25	33	340	340	180	6,7
VLW 1-19/22	LW 40	19000	25	40	340	340	190	10,0

Esempio: la campanella VLW 1-6/7/8 può essere utilizzata per imbragature a 1 braccio con catena diametro 6 mm, 7 mm e 8 mm.

Example: VLW 1-6/7/8 can be used for 1 leg slings with 6 mm, 7 mm and 8 mm chain.

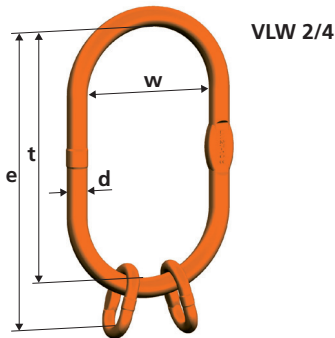

VLW 2/4

Tipo Type	Assemblaggio Consisting of	Portata 0°-45° WLL 0°-45° Kg	Idonea per ganci DIN 15401 Can be used up to single hook acc. to DIN 15401 n°	Dimensioni Dimensions				Peso Weight Kg
				d mm	e mm	t mm	w mm	
VLW 2-6/7/8 4-6	LW 22 + 2 BW 13	3550	25	22	394	340	180	3,5
VLW 2-10 4-7-8	LW 27 + 2 BW 16	5600	25	27	410	340	180	5,1
VLW 2-13 4-10	LW 32 + 2 BW 20	9500	25	33	425	340	180	8
VLW 2-16 4-13	LW 40 + 2 BW 22	14000	25	40	455	340	180	12,3
VLW 2-19 4-16	LW 40 + 2 BW 26	21200	25	40	480	340	180	13,8

Esempio: la campanella VLW 2-6/7/8 4-6 può essere utilizzata per imbragature a 2 bracci con catena diametro 6 mm, 7 mm e 8 mm e a 4 bracci con catena diametro 6 mm.

Example: VLW 2-6/7/8 4-6 can be used for 6 mm, 7 mm and 8 mm 2 legs slings and 6 mm 4 legs slings chain.

Campanella maggiorata VSW 2/4

VSW 2/4 Oversize master link assembly

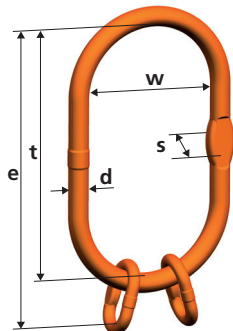

Tipo Type	Assemblaggio Consisting of	Portata 0°-45° WLL 0°-45° Kg	Idonea per ganci DIN 15401 Can be used up to single hook acc. to DIN 15401 n°	Dimensioni Dimensions					Peso Weight Kg
				d mm	e mm	t mm	w mm	s mm	
VSW 2-10 4-8	SAW 30 + 2 BW 20	5600	40	30	515	430	220	24	8,2
VSW 2-13 4-10	SAW 33 + 2 BW 20	9500	40	33	515	430	220	26	9,7
VSW 2-16 4-13	SAW 36 + 2 BW 22	14000	40	36	545	430	220	29	12,3
VSW 2-19/20 4-16	SAW 45 + 2 BW 26	21200	40	45	570	430	220	-	19,5

Esempio: la campanella VSW 2-10/4-8 può essere utilizzata per imbragature a 2 bracci con catena diametro 10 mm e a 4 bracci con catena diametro 8 mm.

Example: VSW 2-10/4-8 can be used for 10 mm 2 legs slings and 8 mm 4 legs slings chain.

Catene e accessori Winner - Grado 10

Winner chain and
accessory system in G10

Campanella speciale VSAW G10

VSAW Master link assembly G10

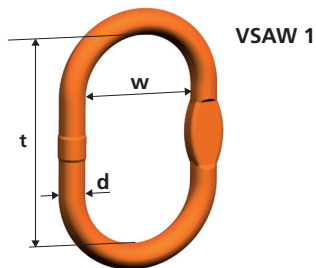

VSAW 1

Tipo Type	Assemblaggio Consisting of	Portata WLL Kg	Idonea per ganci DIN 15401 Can be used up to single hook acc. to DIN 15401 n°	Dimensioni Dimensions			Peso Weight Kg
				d mm	t mm	w mm	
VSAW 1-10/13	SAW 32 + BW 20	10000	50	33	500	250	10,00
VSAW 1-16	SAW 32	10000	50	33	500	250	9,33
VSAW 1-19	SAW 40	16000	50	40	460	250	13,13
VSAW 1-22	SAW 45	22400	50	45	500	250	17,81
VSAW 1-26	SAW 50	33600	50	50	460	250	21,00
VSAW 1-32	SAW 56	40000	50	56	460	250	26,10
VSAW 1-32 320	SAW 60	40000	100	60	800	320	48,00

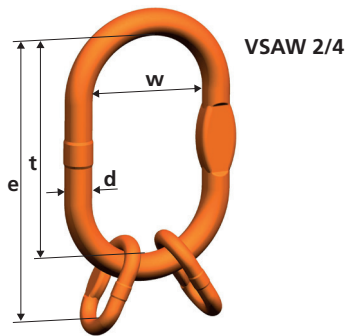

VSAW 2/4

Tipo Type	Assemblaggio Consisting of	Portata 0°-45° WLL 0°-45° Kg	Idonea per ganci DIN 15401 Can be used up to single hook acc. to DIN 15401 n°	Dimensioni Dimensions				Peso Weight Kg
				e mm	d mm	t mm	w mm	
VSAW 2-10/13	4-10 SAW 32 + 2 BW 20	9500	50	585	33	500	250	10,69
VSAW 2-16	4-13 SAW 40 + 2 BW 22	14000	50	575	40	460	250	15,45
VSAW 2-19/20	4-16 SAW 45 + 2 BW 26	21200	50	640	45	500	250	21,65
VSAW 2-22	4-19/20 SAW 50 + 2 BW 32	30000	50	610	50	460	250	27,32
VSAW 2-26	4-22 SAW 56 + 2 BW 32	40000	50	610	56	460	250	34,30
VSAW 2-26	4-22/320 SAW 60 + 2 BW 32	40000	100	950	60	800	320	54,32



Catene e accessori Winner - Grado 10

Winner chain and
accessory system in G10

Campanella tripla VAW

VAW Master link assembly

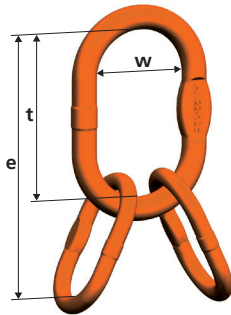

Tipo Type	Assemblaggio Consisting of	Portata 0°-45° WLL 0°-45° Kg	Idonea per ganci DIN 15401 Can be used up to single hook acc. to DIN 15401 n°	Dimensioni Dimensions			Peso Weight Kg
				e mm	t mm	w mm	
VAW 6/7	AW 18 + 2 AW 13	5000	5	245	135	75	1,70
VAW 8	AW 22 + 2 AW 16	6300	6	270	160	90	2,66
VAW 10	AW 26 + 2 AW 18	9500	8	315	180	100	4,30
VAW 13	AW 32 + 2 AW 26	16100	10	380	200	110	9,05
VAW 16	AW 36 + 2 AW 32	25100	16	460	260	140	14,50
VAW 19/20	AW 50 + 2 MW 36	41100	32	625	350	190	31,50
VAW 22	AW 50 + 2 AW 45	47400	32	690	350	190	42,19
VAW 26	AW 56 + 2 AW 50	58000	32	750	400	200	56,40
VAW 32	AW 72 + 2 AW 56	85000	50	860	460	250	99

Campanella Clevis KOW

KOW Clevis reeving link

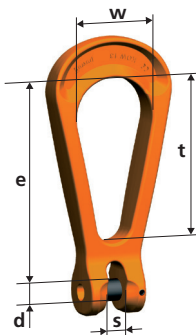

Tipo Type	Portata WLL Kg	Dimensioni Dimensions					Peso Weight Kg
		d mm	e mm	s mm	t mm	w mm	
KOW 7	1900	9	92	9	70	34	0,28
KOW 8	2500	10	91	9	70	34	0,3
KOW 10	4000	13	128	12	102	50	0,7
KOW 13	6700	16	169	15	136	66	1,4
KOW 16	10000	20	214	18	172	83	2,74

Catene e accessori Winner - Grado 10

Winner chain and
accessory system in G10

Complesso ad un braccio KAGW 1

KAGW 1 Single leg clevis master set

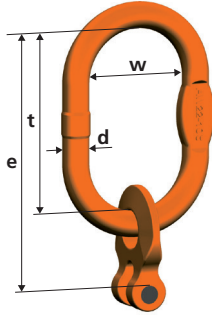

Tipo Type	Portata WLL Kg	Per catena For chain Ø	Idonea per ganci DIN 15401 Can be used up to single hook acc. to DIN 15401 n°	Dimensioni Dimensions				Peso Weight Kg
				d mm	e mm	t mm	w mm	
KAGW 1-6	1400	6	2,5	13	141	110	60	0,42
KAGW 1-7	1900	7	2,5	13	153	110	60	0,54
KAGW 1-8	2500	8	2,5	16	153	110	60	0,73
KAGW 1-10	4000	10	5	19	186	135	75	1,28
KAGW 1-13	6700	13	6	23	223	160	90	2,3
KAGW 1-16	10000	16	8	27	254	180	100	3,63
KAGW 1-19	14000	19	10	33	290	200	110	6,5
KAGW 1-22	19000	22	16	36	362	260	140	9,4

Complesso a due bracci KAGW 2

KAGW 2 Two legs clevis master set

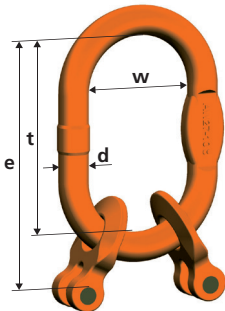

Tipo Type	Portata 0°-45°/45°-60° WLL 0°-45°/45°-60° Kg	Per catena For chain Ø	Idonea per ganci DIN 15401 Can be used up to single hook acc. to DIN 15401 n°	Dimensioni Dimensions				Peso Weight Kg
				d mm	e mm	t mm	w mm	
KAGW 2-6	2000/1400	6	2,5	13	141	110	60	0,5
KAGW 2-7	2650/1900	7	2,5	16	152,5	110	60	0,93
KAGW 2-8	3550/2500	8	5	19	177,5	135	75	1,26
KAGW 2-10	5600/4000	10	6	23	211	160	90	2,3
KAGW 2-13	9500/6700	13	8	27	243	180	100	3,86
KAGW 2-16	14000/10000	16	10	33	274	200	110	6,5
KAGW 2-19	20000/14000	19	16	36	354	260	140	11
KAGW 2-22	26500/19000	22	25	45	442	340	180	19,2

Complesso a quattro bracci KAGW 4

KAGW 4 Four legs clevis master set

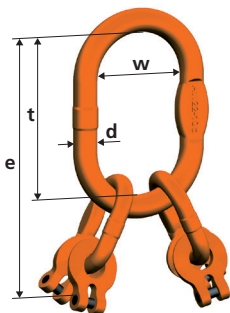

Tipo Type	Portata 0°-45°/45°-60° WLL 0°-45°/45°-60° Kg	Per catena For chain Ø	Idonea per ganci DIN 15401 Can be used up to single hook acc. to DIN 15401 n°	Dimensioni Dimensions				Peso Weight Kg
				d mm	e mm	t mm	w mm	
KAGW 4-6	3000/2120	6	5	19	220	135	75	1,52
KAGW 4-7	4000/2800	7	6	23	272,5	160	90	3,12
KAGW 4-8	5300/3750	8	6	23	272,5	160	90	3,12
KAGW 4-10	8000/6000	10	8	27	316	180	100	6,14
KAGW 4-13	14000/10000	13	10	33	378	200	110	9,26
KAGW 4-16	21200/15000	16	16	36	474	260	140	14,9
KAGW 4-19	30000/21200	19	32	50	594	350	190	32,4
KAGW 4-22	40000/28000	22	32	50	622	350	190	37,6

Disponibili anche con campanella maggiorata.
Available also with enlarged master link.

Catene e accessori Winner - Grado 10

Winner chain and
accessory system in G10

Complessivo ad un braccio VXKW 1

VXKW 1 Single leg clevis master set

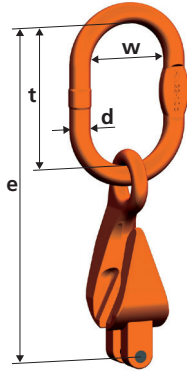

Tipo Type	Portata WLL Kg	Per catena For chain Ø	Idonea per ganci DIN 15401 Can be used up to single hook acc. to DIN 15401 n°	Dimensioni Dimensions				Peso Weight Kg
				d mm	e mm	t mm	w mm	
VXKW 1-5	1000	5	1,6	10	164	80	50	0,44
VXKW 1-6	1400	6	2,5	13	194	110	60	0,64
VXKW 1-7	1900	7	2,5	13	232	110	60	0,96
VXKW 1-8	2500	8	2,5	16	232	110	60	1,16
VXKW 1-10	4000	10	5	19	294	135	75	2,11
VXKW 1-13	6700	13	6	23	363	160	90	4,30
VXKW 1-16	10000	16	8	27	413	180	100	7,26

Complessivo a due bracci VXKW 2

VXKW 2 Two legs clevis master set

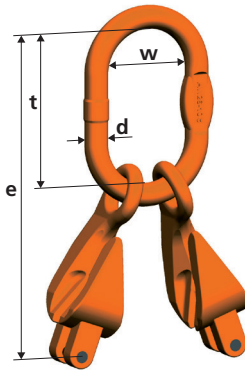

Tipo Type	Portata 0°-45°/45°-60° WLL 0°-45°/45°-60° Kg	Per catena For chain Ø	Idonea per ganci DIN 15401 Can be used up to single hook acc. to DIN 15401 n°	Dimensioni Dimensions				Peso Weight Kg
				d mm	e mm	t mm	w mm	
VXKW 2-5	1400 / 1000	5	1,6	10	164	80	50	0,74
VXKW 2-6	2000 / 1400	6	2,5	13	194	110	60	0,94
VXKW 2-7	2650 / 1900	7	2,5	16	232	110	60	1,77
VXKW 2-8	3550 / 2500	8	5	19	257	135	75	2,12
VXKW 2-10	5600 / 4000	10	6	23	319	160	90	4,1
VXKW 2-13	9500 / 6700	13	8	27	383	180	100	7,86
VXKW 2-16	14000 / 10000	16	10	33	433	200	110	13,74

Complessivo a quattro bracci VXKW 4

VXKW 4 Four legs clevis master set

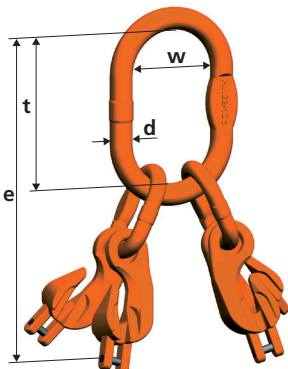

Tipo Type	Portata 0°-45°/45°-60° WLL 0°-45°/45°-60° Kg	Per catena For chain Ø	Idonea per ganci DIN 15401 Can be used up to single hook acc. to DIN 15401 n°	Dimensioni Dimensions				Peso Weight Kg
				d mm	e mm	t mm	w mm	
VXKW 4-5	2000 / 1500	5	2,5	13	238	110	60	1,72
VXKW 4-6	3000 / 2120	6	5	19	273	135	75	2,4
VXKW 4-7	4000 / 2800	7	6	23	352	160	90	4,84
VXKW 4-8	5300 / 3750	8	6	23	352	160	90	4,84
VXKW 4-10	8000 / 6000	10	8	27	424	180	100	8,82
VXKW 4-13	14000 / 10000	13	10	33	518	200	110	17,26
VXKW 4-16	21200 / 15000	16	16	36	633	260	140	29,26

Disponibili anche con campanella maggiorata.
Available also with enlarged master link.

Catene e accessori Winner - Grado 10

Winner chain and
accessory system in G10

Complesso ad un braccio LXXW 1 con campanella maggiorata

LXXW 1 Single leg oversize clevis master set

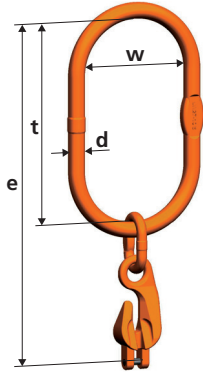

Tipo Type	Portata WLL Kg	Idonea per ganci DIN 15401 Can be used up to single hook acc. to DIN 15401 n°	Dimensioni Dimensions				Peso Weight Kg
			d mm	e mm	t mm	w mm	
LXXW 1-6	1400	25	23	478	340	50	3,70
LXXW 1-8	2500	25	23	516	340	60	4,00
LXXW 1-10	4000	25	27	569	340	60	6,00
LXXW 1-13	6700	25	27	629	340	60	7,80
LXXW 1-16	10000	25	33	688	340	75	12,70

Complesso a due bracci LXXW 2 con campanella maggiorata

LXXW 2 Two legs oversize clevis master set

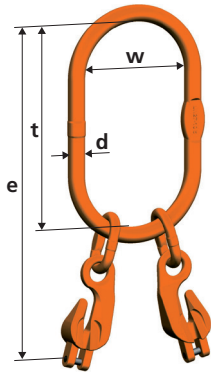

Tipo Type	Portata 0°-45°/45°-60° WLL 0°-45°/45°-60° Kg	Idonea per ganci DIN 15401 Can be used up to single hook acc. to DIN 15401 n°	Dimensioni Dimensions				Peso Weight Kg
			d mm	e mm	t mm	w mm	
LXXW 2-6	2000 / 1400	25	23	478	340	180	4,14
LXXW 2-8	3550 / 2500	25	23	516	340	180	4,80
LXXW 2-10	5600 / 4000	25	27	569	340	180	7,60
LXXW 2-13	9500 / 6700	25	33	629	340	180	13,50
LXXW 2-16	14000 / 10000	25	40	688	340	180	21,90

Complesso a quattro bracci LXXW 4 con campanella maggiorata

LXXW 4 Four legs oversize clevis master set

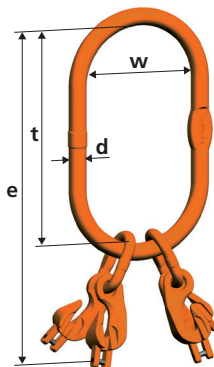

Tipo Type	Portata 0°-45°/45°-60° WLL 0°-45°/45°-60° Kg	Idonea per ganci DIN 15401 Can be used up to single hook acc. to DIN 15401 n°	Dimensioni Dimensions				Peso Weight Kg
			d mm	e mm	t mm	w mm	
LXXW 4-6	3000 / 2120	25	23	478	340	180	4,70
LXXW 4-8	5300 / 3750	25	27	532	340	180	7,60
LXXW 4-10	8000 / 6000	25	33	584	340	180	13,10
LXXW 4-13	14000 / 10000	25	40	659	340	180	23,10
LXXW 4-16	21200 / 15000	25	40	713	340	180	33,10

Maglia di giunzione CW

CW Connecting link

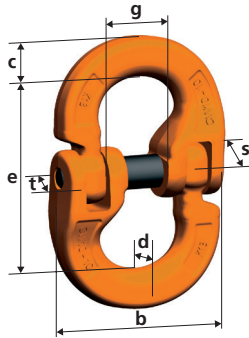

Tipo Type	Portata WLL Kg	Dimensioni Dimensions							Peso Weight Kg
		b mm	c mm	d mm	e mm	g mm	s mm	t mm	
CW 5	1000	34	7	7	36	13	9	12	0,05
CW 6	1400	39	8	8	44	14	11	13	0,06
CW 7	1900	46	10	9	51	17	13	16	0,12
CW 8	2500	55	12	10	62	18	14	20	0,18
CW 10	4000	64	15	13	72	24	18	22	0,42
CW 13	6700	79	20	17	88	28	22	26	0,84
CW 16	10000	105	24	24	103	33	29	35	1,40
CW 19-20	16000	123	32	25	115	44	35	45	2,40
CW 22	19000	148	36	26	161	52	39	46	4,15
CW 26	26500	175	40	30	190	60	46	49	6,70
CW 32	40000	216	47	35	206	80	56	63	11,20

Maglia di giunzione inamovibile CLW

CLW Unremovable connecting link

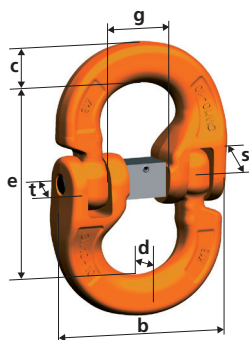

Tipo Type	Portata WLL Kg	Dimensioni Dimensions							Peso Weight Kg
		b mm	c mm	d mm	e mm	g mm	s mm	t mm	
CLW 7	1900	47	10	9	51	17	13	14	0,12
CLW 10	4000	64	15	13	72	24	18	22	0,42
CLW 13	6700	79	20	17	88	28	22	26	0,84
CLW 16	10000	106	21	21	103	33	29	31	1,40
CLW 19/20	16000	123	30	24	115	42	35	37	2,40
CLW 22	19000	148	34	25	161	51	39	42	4,15
CLW 26	26500	175	40	30	190	60	46	49	6,70
CLW 32	40000	216	47	35	206	80	56	63	11,20

Maglia di giunzione per brache di poliestere CARW

CARW Webbing slings connecting link

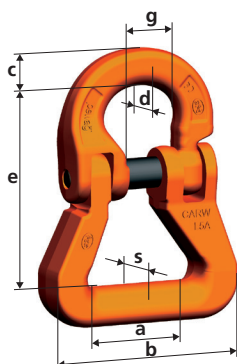

Tipo Type	Portata WLL Kg	Dimensioni Dimensions							Peso Weight Kg
		a mm	b mm	c mm	d mm	e mm	g mm	s mm	
CARW 8	2500	29	68	12	10	66	18	18	0,4
CARW 10	4000	40	82	15	13	81	24	21	0,5
CARW 13	6700	44	100	20	17	104	28	28	1,2
CARW 16	10000	47	110	21	21	113	33	40	2
CARW 22	19000	110	215	34	25	190	48	58	6,5

Catene e accessori Winner - Grado 10

Winner chain and
accessory system in G10

Gancio ad occhio HSW

HSW Eye sling hook

- Con sicurezza forgiata
- With forged safety latch

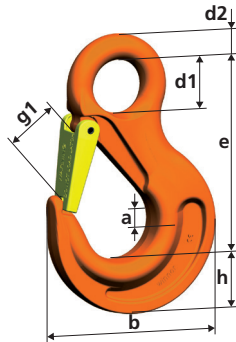

Tipo Type	Portata WLL Kg	Dimensioni Dimensions							Peso Weight Kg
		a mm	b mm	d1 mm	d2 mm	e mm	g1 mm	h mm	
HSW 5-6	1400	17	68	20	10	85	19	21	0,3
HSW 7-8	2500	19	88	25	11	106	26	27	0,5
HSW 10	4000	26	109	34	16	131	31	33	1,1
HSW 13	6700	33	134	43	19	164	39	44	2,20
HSW 16	10000	40	155	50	25	183	45	50	3,5
HSW 19-20	16000	48	178	55	27	205	53	55	5,80
HSW 22	19000	50	196	60	29	225	62	62	8,00
HSW 26	26500	70	236	70	35	259	73	75	13,40
HSW 32	40000	82	291	66	45	299	87	97	27,5

Gancio autobloccante LHW

LHW Self locking hook

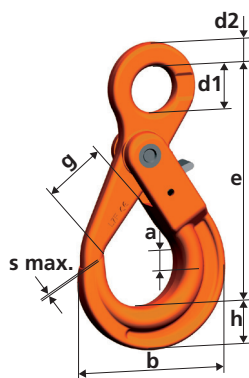

Tipo Type	Portata WLL Kg	Dimensioni Dimensions								Peso Weight Kg
		a mm	b mm	d1 mm	d2 mm	e mm	g mm	h mm	s max mm	
LHW 5-6	1400	17	71	21	11	110	28	20	1	0,5
LHW 7-8	2500	20	88	25	12	136	34	26	1	0,9
LHW 10	4000	25	107	35	15	169	45	30	1	1,5
LHW 13	6700	35	138	40	20	205	52	40	1,5	2,7
LHW 16	10000	41	168	50	27	251	60	50	2	5,7
LHW 19-20	16000	50	194	60	30	290	70	62	2	9,8
LHW 22	19000	52	211	70	32	322	81	65	2	12,40

Gancio fonderia FW

FW Foundry hook

- Utilizzare esclusivamente nei casi consentiti dalle norme.
- To use only when allowed by law.

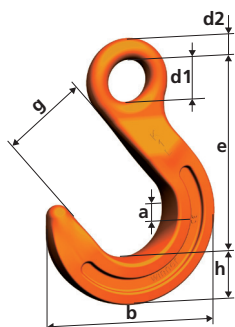

Tipo Type	Portata WLL Kg	Dimensioni Dimensions							Peso Weight Kg
		a mm	b mm	d1 mm	d2 mm	e mm	g mm	h mm	
FW 7-8	2500	25	118	24	11	131	64	29	0,92
FW 10	4000	32	143	31	14	158	76	35	1,77
FW 13	6700	40	170	39	17	190	89	42	2,82
FW 16	10000	46	200	47	22	224	102	50	5,03
FW 19-20	16000	54	231	56	28	260	114	61	9,2
F 22*	15000	61	260	47	30	265	127	70	9,4
F 26*	21200	72	280	54	34	305	136	80	19,2
F 32*	31500	83	336	60	37	327	152	93	28,0

* Grado 8 / G8.

Catene e accessori Winner - Grado 10

Winner chain and
accessory system in G10

Gancio girevole WSBW

WSBW Swivel hook

- Con cuscinetto per rotazioni del carico.
- Temperatura max consentita 120°C
- With bearing to rotate when loaded.
- Max operating temperature 120°C

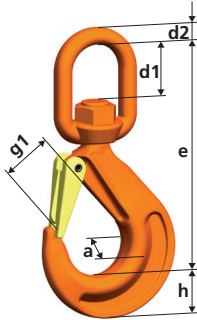

Tipo Type	Portata WLL Kg	Dimensioni Dimensions						Peso Weight Kg
		a mm	d1 mm	d2 mm	e mm	g1 mm	h mm	
WSBW 7/8	2500	19	37	12	154	26	28	0,85
WSBW 10	4000	25	41	16	183	30	33	1,56
WSBW 13	6700	30	47	20	221	38	40	2,71

Gancio autobloccante girevole WLHW senza cuscinetto

WLHW Swivel self locking hook without bearing

- **Attenzione:** per effettuare rotazioni del carico utilizzare esclusivamente ganci con cuscinetto.
- **Warning:** to rotate the load, exclusively hooks with bearing must be considered.

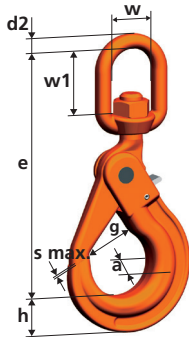

Tipo Type	Portata WLL Kg	Dimensioni Dimensions								Peso Weight Kg
		a mm	d2 mm	e mm	g mm	h mm	w mm	w1 mm	s max mm	
WLHW 5-6	1400	17	12	160	28	20	35	35	1	0,6
WLHW 7-8	2500	20	13	181	34	26	35	35	1	1,1
WLHW 10	4000	29	16	218	45	30	42	40	1	2,0
WLHW 13	6700	35	20	269	52	40	49	47	1,5	4,0
WLHW 16	10000	41	24	319	60	50	60	60	2	6,8

Gancio autobloccante girevole WLHBW con cuscinetto

WLHBW Swivel self locking hook with bearing

- **Attenzione:** per effettuare rotazioni del carico utilizzare esclusivamente ganci con cuscinetto.
- Temperatura max di lavoro: 120 °C.
- **Warning:** to rotate the load, exclusively hooks with bearing must be considered.
- Max operating temperature: 120°C.

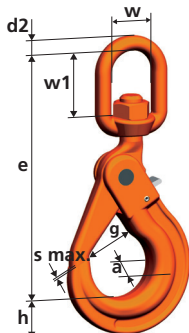

Tipo Type	Portata WLL Kg	Dimensioni Dimensions								Peso Weight Kg
		a mm	d2 mm	e mm	g mm	h mm	w mm	w1 mm	s max mm	
WLHBW 5-6	1400	17	12	160	28	20	35	35	1	0,6
WLHBW 7-8	2500	20	13	181	34	26	35	35	1	1,1
WLHBW 10	4000	29	16	218	45	30	42	40	1	2,0
WLHBW 13	6700	35	20	269	52	40	49	47	1,5	4,0
WLHBW 16	10000	41	24	319	60	50	60	60	2	6,8

Gancio accorciatore PW

PW Grab hook

- Mantiene invariata la portata della braca.
- Reduction of WLL not required.

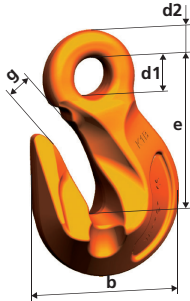

Tipo Type	Portata WLL Kg	Dimensioni Dimensions					Peso Weight Kg
		b mm	d1 mm	d2 mm	e mm	g mm	
PW 5	1000	40	11	9	47	7	0,13
PW 6	1400	44	12	9	50	7	0,15
PW 7-8	2500	57	16	12	65	9	0,37
PW 10	4000	71	20	14	77	12	0,7
PW 13	6700	92	26	19	101	15	1,56
PW 16	10000	113	32	23	121	19	2,9
PW 19-20	16000	150	36	27	151	25	6
PW 22	19000	165	42	31	170	27	8,30
PW 26	26500	195	50	37	201	32	13,80
PW 32	40000	242	60	43	243	38	25,40

Gancio accorciatore PSW con dispositivo di sicurezza

PSW Grab hook with safety catch

- Mantiene invariata la portata della braca.
- Reduction of WLL not required.

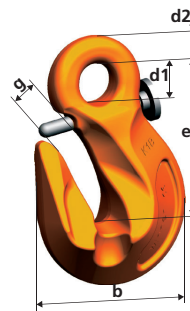

Tipo Type	Portata WLL Kg	Dimensioni Dimensions					Peso Weight Kg
		b mm	d1 mm	d2 mm	e mm	g mm	
PSW 7-8	2500	57	16	12	65	9	0,37
PSW 10	4000	71	20	14	77	12	0,70
PSW 13	6700	92	26	19	101	15	1,60
PSW 16	10000	113	32	23	121	19	2,90

Gancio accorciatore KPW e KPSW con dispositivo di sicurezza

KPW and KPSW Clevis grab hook with safety catch

- Mantiene invariata la portata della braca.
- Reduction of WLL not required.

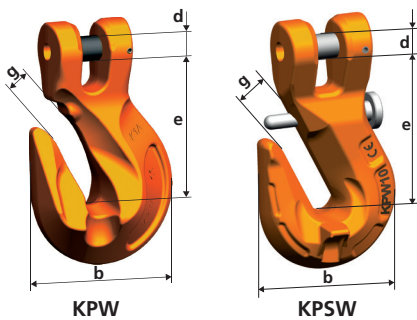

Tipo Type	Tipo Type	Portata WLL Kg	Dimensioni Dimensions				Peso Weight Kg
			b mm	d mm	e mm	g mm	
KPW 5-6	-	1400	44	7,4	47	7	0,17
KPW 7	KPSW 7	1900	57	9	63	9	0,44
KPW 8	KPSW 8	2500	57	10	63	9	0,44
KPW 10	KPSW 10	4000	71	12,5	78	12	0,85
KPW 13	KPSW 13	6700	92	16	93	15	1,75
KPW 16	KPSW 16	10000	113	20	115	19	3,30
KPW 19-20	-	16000	150	24	141	25	6,15
KPW 22	-	19000	165	27	158	27	9

Gancio accorciatore XKW

XKW Clevis shortening hook

- Mantiene invariata la portata della braca.
- Reduction of WLL not required.

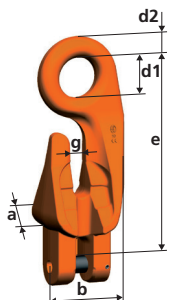

Tipo Type	Portata WLL Kg	Dimensioni Dimensions						Peso Weight Kg
		a mm	b mm	d1 mm	d2 mm	e mm	g mm	
XKW 5-6	1400	29	37	18	9	84	8	0,3
XKW 7	1900	39	54	24	12	122	11	0,62
XKW 8	2500	39	54	24	12	122	11	0,63
XKW 10	4000	50	70	31	14	159	13	1,25
XKW 13	6700	64	92	37	18	203	15	2,7
XKW 16	10000	80	102	48	24	233	20	4,8

Catene e accessori Winner - Grado 10

Winner chain and
accessory system in G10

Gancio a perno KHSW

KHSW Clevis sling hook

- Con sicurezza forgiata.
- With safety latch

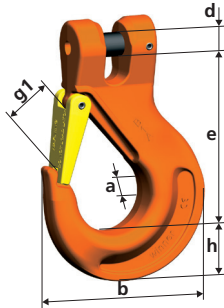

Tipo Type	Portata WLL Kg	Dimensioni Dimensions						Peso Weight Kg
		a mm	b mm	d mm	e mm	g1 mm	h mm	
KHSW 5-6	1400	15	66	7	69	19	20	0,2
KHSW 7	1900	19	90	9	95	26	28	0,6
KHSW 8	2500	19	90	10	95	26	28	0,6
KHSW 10	4000	25	108	12,5	109	31	35	1,1
KHSW 13	6700	34	131	16	136	39	41	2
KHSW 16	10000	37	153	20	155	45	49	3,48
KHSW 19-20	16000	51	177	24	184	53	53	5,00
KHSW 22	19000	52	196	27	214	62	62	9,00

Gancio a bocca larga BKHSW

BKHSW Oversize clevis sling hook

- Alternativa al gancio tipo KHSW quando è necessaria un'apertura maggiore (g1).
- Con sicurezza forgiata.
- Alternative to the KHSW hook with wider throat opening (g1).
- With safety catch.

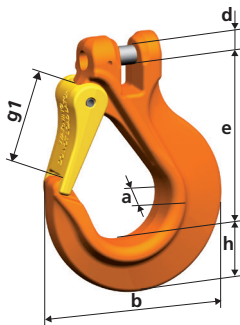

Tipo Type	Portata WLL Kg	Dimensioni Dimensions						Peso Weight Kg
		a mm	b mm	d mm	e mm	g1 mm	h mm	
BKHSW 8	2500	25	98	10	93	32	27	0,9
BKHSW 10	4000	30	119	12,5	111	38	33	1,5

Gancio autobloccante KLHW

KLHW Clevis self locking hook

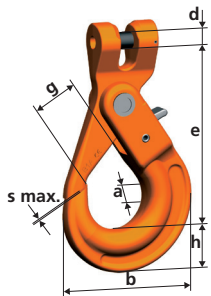

Tipo Type	Portata WLL Kg	Dimensioni Dimensions							Peso Weight Kg
		a mm	b mm	d mm	e mm	g mm	h mm	s max mm	
KLHW 5/6	1400	17	71	7	94	28	20	1	0,5
KLHW 7	1900	20	88	9	123	34	26	1	0,9
KLHW 8	2500	20	88	10	123	34	26	1	0,9
KLHW 10	4000	29	107	12,5	144	45	30	1	1,6
KLHW 13	6700	35	138	16	180	52	40	1,5	2,9
KLHW 16	10000	41	168	20	217	60	50	2	5,8
KLHW 19/20	16000	50	194	24	259	70	62	2	9,9
KLHW 22	19000	52	211	27	286	81	65	2	12,8
KLHW 26	26500	61	253	33	338	100	79	2	20,5

Gancio fonderia KFW

KFW Clevis foundry hook

- Utilizzare esclusivamente nei casi consentiti dalle norme.
- To use only when allowed by law.

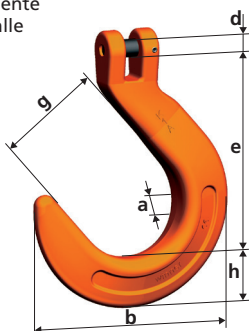

Tipo Type	Portata WLL Kg	Dimensioni Dimensions						Peso Weight Kg
		a mm	b mm	d mm	e mm	g mm	h mm	
KFW 7	1900	25	118	9	121	64	29	1,00
KFW 8	2500	25	118	10	120	64	29	1,00
KFW 10	4000	32	143	12,5	140	76	35	1,78
KFW 13	6700	40	170	16	170	89	42	2,96

Catene e accessori Winner - Grado 10

Winner chain and
accessory system in G10

Gancio anticocciante KCHW

KCHW Clevis C-hook

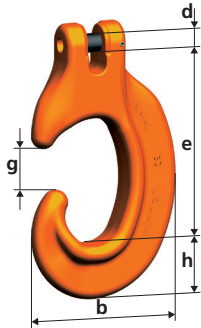

Tipo Type	Portata WLL Kg	Dimensioni Dimensions					Peso Weight Kg
		b mm	d mm	e mm	g mm	h mm	
KCHW 7	1900	74	9	91	20	28	0,5
KCHW 8	2500	74	10	90	20	28	0,5
KCHW 10	4000	107	12,5	129	28	39	1,4
KCHW 13	6700	137	16	166	41	51	3
KCHW 16	10000	166	20	205	45	60	5,3

Forcella KSCHW

KSCHW Clevis shackle

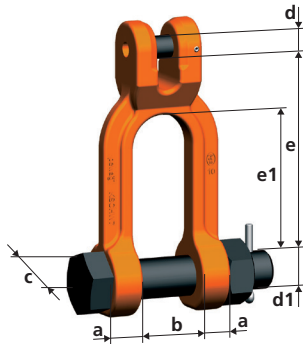

Tipo Type	Portata WLL Kg	Dimensioni Dimensions							Peso Weight Kg
		a mm	b mm	c mm	d mm	d1 mm	e mm	e1 mm	
KSCHW 7	1900	12	26	31	9	16	76	54	0,49
KSCHW 8	2500	12	26	31	10	16	76	54	0,49
KSCHW 10	4000	16	32	39	12,5	20	105	76	0,9
KSCHW 13	6700	21	42	50	16	24	113	77	1,89

Anello KRW

KRW Coupling ring

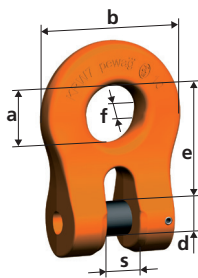

Tipo Type	Portata WLL Kg	Dimensioni Dimensions						Peso Weight Kg
		a mm	b mm	d mm	e mm	f mm	s mm	
KRW 5-6	1400	18	38	7,4	31	8	7	0,08
KRW 7	1900	24	54	9	43	11	10	0,2
KRW 8	2500	24	54	10	43	11	10	0,2
KRW 10	4000	28	63	12,5	51	14	12	0,36
KRW 13	6700	33	76	16	63	17	15	0,7
KRW 16	10000	40	88	20	74	20	18	1,2
KRW 19-20	16000	50	114	24	94	24	23	2,4
KRW 22	19000	50	122	27	102	27	25	3,20



Catene e accessori Winner - Grado 10

Winner chain and
accessory system in G10

Gancio piatto BWW

BWW Sheet metal plate hook

- Per sollevamento lamiera.
- Utilizzare con brache a 3 bracci.
- Si raccomanda l'utilizzo con angolo β 15-30°.
- For lifting sheet metal stacks and boards.
- Use min. 3 legs chain slings.
- Recommended angle of inclination of the sling: β 15-30°

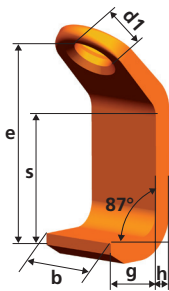

Tipo Type	Portata WLL Kg	Dimensioni Dimensions						Peso Weight Kg
		b mm	d1 mm	e mm	g mm	h mm	s mm	
BWW 7-8	2500	50	28	131	55	18	80	1,5
BWW 10	4000	70	36	168	65	20	100	2,8
BWW 13	6700	80	40	207	90	26	130	5,3
BWW 16	10000	100	50	261	110	33	160	10,50
BWW 19-20	16000	120	60	302	130	40	185	17,50
BWW 22	19000	140	75	363	150	50	220	30,50

Gancio a forca GHW

GHW Fork hook

- Per sollevamento lamiera.
- Da utilizzare esclusivamente in coppia.
- Si raccomanda l'utilizzo con angolo β 30-45°.
- For lifting large sheet metal stacks and large boards.
- Use only in pairs
- Recommended angle of inclination of the sling: β 30-45°

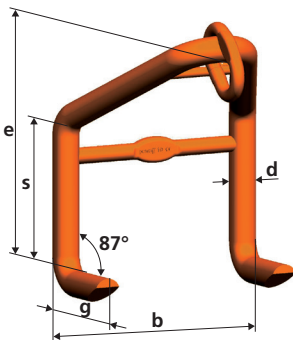

Tipo Type	Portata WLL Kg	Dimensioni Dimensions					Maglia BW BW link	Peso Weight Kg
		b mm	d mm	e mm	g mm	s mm		
GHW 5-6	1400	190	23	203	65	100	BW 13	2,70
GHW 7-8	2500	254	30	300	100	150	BW 16	6,50
GHW 10	4000	380	40	402	130	200	BW 22	16,1



Catene e accessori Winner - Grado 10

Winner chain and
accessory system in G10

Grillo SCHW dritto SCHW Dee shackle

- Grilli di acciaio G10.
- Portata in accordo alla catena.
- Non può essere montato nella maglia della catena.
- G10 shackles.
- WLL according to the chain.
- Cannot be mounted directly to the chain.

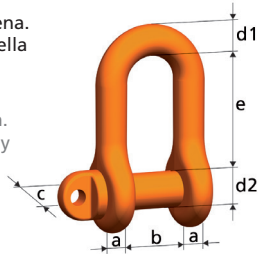

Tipo Type	Portata WLL Kg	Dimensioni Dimensions						Peso Weight Kg
		a mm	b mm	c mm	d1 mm	d2 mm	e mm	
SCHW 5	1000	7	11	16	8	8	24	0,05
SCHW 6	1400	8	14	20	10	10	30	0,09
SCHW 7/8	2500	10	17	24	12	12	36	0,20
SCHW 10	4000	13	21	32	15	16	49	0,30
SCHW 13	6700	17	27	40	19	20	61	0,70
SCHW 16	10000	21	33	48	23	24	73	1,30

Grillo GSCHW a omega GSCHW Bow shackle

- Grilli di acciaio G10.
- Portata in accordo alla catena.
- Non può essere montato nella maglia della catena.
- G10 shackles.
- WLL according to the chain.
- Cannot be mounted directly to the chain.

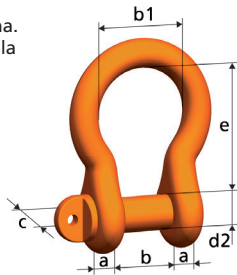

Tipo Type	Portata WLL Kg	Dimensioni Dimensions						Peso Weight Kg
		a mm	b mm	b1 mm	c mm	d2 mm	e mm	
GSCHW 7/8	2500	13	22	32	34	16	51	0,35
GSCHW 10	4000	16	27	43	40	19	64	0,64
GSCHW 13	6700	19	31	51	46	22	76	1,03
GSCHW 16	10000	25	43	68	59	28	95	2,23

Gancio KNEW KNEW Toggle

Thanks to its special low design, this toggle is frequently used for general transportation purposes in the construction industry, for instance of sheet piles. As the toggle is welded into the sling with the next size up chain link, it takes up little space and is also suitable for small sizes. We recommend using a 10 mm chain for the transportation of standing sheet piles.

Note: the Knew is welded to a WIN 10 link and dia 8 mm chain of the required length, with a terminal master link

Grazie alle dimensioni compattissime questo dispositivo viene utilizzato nel campo delle costruzioni, per esempio per la movimentazione di palancole. Il dispositivo viene fornito saldato alla catena, ingombra pochissimo ed è idoneo per passare attraverso fori piccoli. Riferirsi alla tabella per il minimo ed il massimo foro consentito. Per la movimentazione di palancole montate, raccomandiamo di utilizzare una catena dia 10mm di grado 10.

Nb: il dispositivo viene fornito saldato con maglia WIN 10 e catena dia 8 mm della lunghezza desiderata, completo di campanella all'estremità

Tipo Type	Portata WLL Kg	Per catena For chain Ø	Dimensioni Dimensions							Maglia di collegamento Connecting link
			a mm	b mm	c mm	d1 mm	d min mm	d max mm	e mm	
KNEW 8	2500	8	17	120	38	15	40	60	10	WIN 10

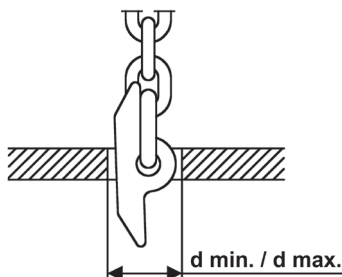

Distributore di carico AGWW

Load distributor AGWW

The capacity of a 4 legs sling is considered as a 3 leg since it is assumed the load is supported by only three legs and the fourth-one is operating as an equalizer. AGWW load distributor allows to share the load on all the four legs and thus be able to establish an higher capacity for the sling. Furthermore it is possible to use a smaller size in order to save on weight without minimizing the overall carrying capacity. Given that the 4 legs sling with load distributor has a higher capacity compared to a standard 4 legs sling, pay attention to the choice of the master ring. The AGWW load distributor is very compact and can be used up to 60° inclination. If in time should occur signs of wear, the device can be turned by 180°, doubling the duration of use.

- Increased carrying capacity
- Usage up to 60° inclination angle
- Double the durability
- Improved wear resistance
- Quick and easy assembly

Convenzionalmente la portata di una braca a 4 bracci viene calcolata su solo 3 bracci, perchè si assume che il carico venga sostenuto da soli 3 bracci e che un braccio faccia da stabilizzatore.

Il distributore di carico AGWW consente di distribuire il carico su tutti i 4 bracci della braca e di conseguenza aumentare la portata dell'imbracatura. Questo consente anche di utilizzare un diametro inferiore di catena e accessori, riducendo il peso della braca, senza penalizzare la portata. Il distributore di carico AGWW ha dimensioni estremamente compatte e può essere utilizzato fino a 60° gradi di inclinazione.

Se nel tempo si dovessero verificare dei segni di usura, il dispositivo può essere girato di 180° gradi raddoppiandone la durata di impiego.

- Portata superiore fino al 25%
- Utilizzo fino a 60° gradi di inclinazione tra i bracci
- Doppia durata di vita
- Resistenza alla fatica aumentata
- Assemblaggio facile e veloce

Tipo Type	Portata del distributore di carico AGWW WLL of load distributor AGWW		Dimensioni Dimensions						Maglia di accoppiamento* Connecting link*	Differenza L1/L2 (maglie di catena) Difference L1/L2 (chain links)	Peso Weight Kg
	0° - 45° Kg	45° - 60° Kg	a mm	e mm	d1 mm	d2 mm	h mm	h1 mm			
AGWW 5/6	2000	1400	148	35	16	22	11	9	CW 8	n° 6 x Ø 5 mm n° 5 x Ø 6 mm	0,54
AGWW 7/8	3550	2500	210	51	22	25	15,5	14	CW 10	n° 6 x Ø 7 mm n° 5 x Ø 8 mm	1,75
AGWW 10	5600	4000	180	32	25	32	23	15,5	CW 13	4	1,56
AGWW 13	9500	6700	240	53	32	40	27	20	CW 16	4	3,60
AGWW 16	14000	10000	300	77	40	50	32	25	CW 19/20	4	7,18
AGWW 19/20	20000	14000	360	79	50	70	45	30	CW 32	5	13,20
AGWW 22	26500	19000	350	124	60	70	50	35	CW 32	5	14,70
AGWW 26	37500	26500	400	130	70	75	60	40	**	4	25,60

• Coefficiente di sicurezza 4.

* Utilizzare questa maglia di accoppiamento per collegare il distributore di carico alla campanella.

** Grillo a omega G 4163 - 55 ton.

• Safety factor 4

* Please use this connex to assemble the load distributor onto the master link assembly.

** Bow shackle G 4163 - WLL 55 ton.

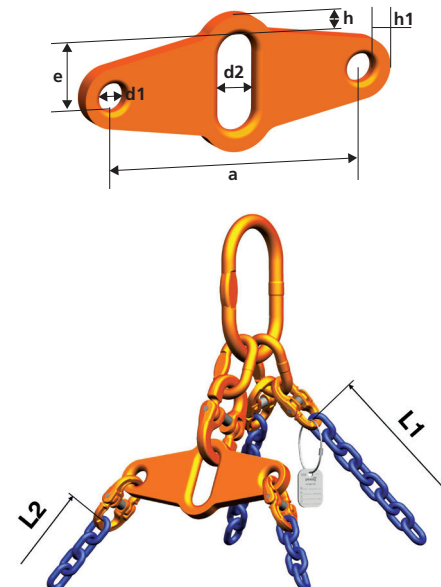

Coefficiente di sicurezza 4
Safety factor 4

Portate brache secondo EN 818
3 e 4 bracci
WLL in according to EN 818
3 and 4 legs

Portate brache con distributore
di carico 3 e 4 bracci
WLL with load distributor
3 and 4 legs

Angolo β Angle β	0°-45°	45°-60°	0°-45°	45°-60°
Fattore di carico Load factor	2,1	1,5	2,8	2
Catena tipo Chain type	Portata Kg WLL Kg			
WIN 5 G10	5	2000	1500	2800
G8	5	1600	1180	2240
WIN 6 G10	6	3000	2120	4000
G8	6	2360	1700	3150
WIN 7 G10	7	4000	2800	5300
G8	7	3150	2240	4000
WIN 8 G10	8	5300	3750	7100
G8	8	4250	3000	5600
WIN 10 G10	10	8000	6000	11200
G8	10	6700	4750	8500
WIN 13 G10	13	14000	10000	19000
G8	13	11200	8000	14000
WIN 16 G10	16	21200	15000	28000
G8	16	17000	11800	22400

Catene e accessori Winner - Grado 10

Winner chain and
accessory system in G10

Compressivi di raccordo UW - Per ganci DIN 15401

UW Transition assembly - For single hook according DIN 15401

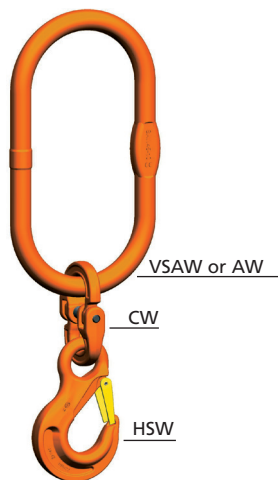

Tipo Type	Gancio Single hook DIN 15401 n°	Portata WLL Kg	Composizione Consisting of	Peso Weight
				Kg
ÜW 50/4 I VSAW-HSW Connex	50	4000	VSAW1-16 / CW16 / HSW10	11,8
ÜW 50/6,7 I VSAW-HSW Connex	50	6700	VSAW1-16 / CW16 / HSW13	12,9
ÜW 50/10 I VSAW-HSW Connex	50	10000	VSAW1-16 / CW16 / HSW16	14,2
ÜW 32/16 I AW-HSW Connex	32	16000	AW50 / CW26 / HSW19-20	29,1
ÜW 32/19 I AW-HSW Connex	32	19000	AW50 / CW26 / HSW22	31,3
ÜW 32/26,5 I AW-HSW Connex	32	26500	AW50 / CW26 / HSW26	36,7
ÜW 50/16 I VSAW-HSW Connex	50	16000	VSAW1-22 / CW22 / HSW19/20	27,8
ÜW 50/19 I VSAW-HSW Connex	50	19000	VSAW1-22 / CW22 / HSW22	30
ÜW 50/26,5 I VSAW-HSW Connex	50	26500	VSAW1-26 / CW26 / HSW26	41,1
ÜW 50/40 I AW-HSW Connex	50	40000	AW72 / CW32 / HSW32	83,7
ÜW 100/26,5 I VSAW-HSW Connex	100	26500	VSAW1-32/320 / CW26 / HSW26	68,1
ÜW 100/40 I VSAW-HSW Connex	100	40000	VSAW1-32/320 / CW32 / HSW32	86,7

Compressivi di raccordo UW - Per ganci DIN 15402

UW Transition assembly - For double hook according DIN 15402

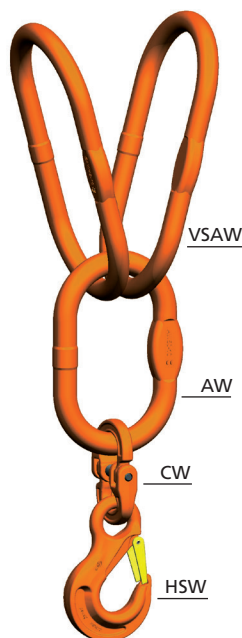

Tipo Type	Gancio Single hook DIN 15402 n°	Portata* WLL* Kg	Composizione Consisting of	Peso Weight
				Kg
ÜW 50/4 II VSAW-HSW Connex	50	4000	2xVSAW1-16 / AW36 / CW16 / HSW10	27,4
ÜW 50/6,7 II VSAW-HSW Connex	50	6700	2xVSAW1-16 / AW36 / CW16 / HSW13	28,5
ÜW 50/10 II VSAW-HSW Connex	50	10000	2xVSAW1-16 / AW36 / CW16 / HSW16	29,0
ÜW 50/16 II VSAW-HSW Connex	50	16000	2xVSAW1-16 / AW36 / CW19/20 / HSW19/20	33,1
ÜW 50/19 II VSAW-HSW Connex	50	19000	2xVSAW1-22 / AW50 / CW26 / HSW22	66,9
ÜW 50/26,5 II VSAW-HSW Connex	50	26500	2xVSAW1-22 / AW50 / CW26 / HSW26	72,3
ÜW 50/40 II VSAW-HSW Connex	50	36000	2xVSAW1-22 / AW50 / CW32 / HSW32	97,3
ÜW 100/26,5 II VSAW-HSW Connex	100	26500	2xVSAW1-32/320 / AW50 / CW26 / HSW26	132,7
ÜW 100/40 II VSAW-HSW Connex	100	40000	2xVSAW1-32/320 / AW50 / CW32 / HSW32	151,3

* Angolo inclinazione campanelle VSAW: 35° max.

* Angle of inclination of VSAW: 35° max.

Grillo Unilock U

U Unilock connecting link

- Non assemblabile con ganci accorciatori PW-PSW.
- Temperatura max consentita: 100°C.
- Cannot be assembled to PW-PSW.
- Max operating temperature: 100°C.

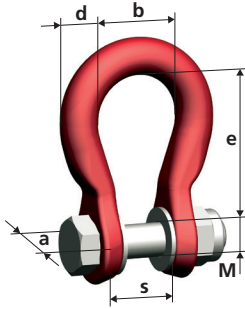

Tipo Type	Portata WLL Kg	Dimensioni Dimensions						Peso Weight Kg
		a mm	b mm	d mm	e mm	s mm	M	
U 5-6	1120	16	21	9	34	11	7	0,07
U 7	1500	22	28	13	49	16	8	0,20
U 8	2000	22	28	13	48	16	10	0,22
U 10	3150	27	35	16	60	20	12	0,38
U 13	5300	34	39	18	72	24	16	0,67
U 16	8000	44	47	23	80	32	20	1,21
U 19/20	12500	52	56	26	96	36	24	1,97
U 26	21200	66	77	33	132	49	30	4,06

Gancio accorciatore KVS

KVS Clevis connector

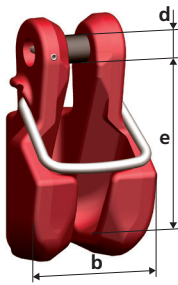

Tipo Type	Portata WLL Kg	Dimensioni Dimensions			Peso Weight Kg
		b mm	d mm	e mm	
KVS 6	1120	36	7	45	0,27
KVS 7	1500	44	9	58	0,50
KVS 8	2000	44	10	58	0,50
KVS 10	3150	55	13	70	0,80
KVS 13	5300	70	16	90	1,53

Gancio ad "S" SM

SM "S" hook

- Temperatura max consentita: 300°C
- Max operating temperature: 300°C

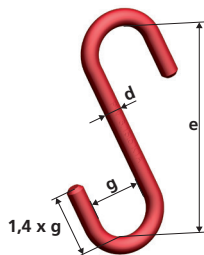

Tipo Type	Portata WLL Kg	Dimensioni Dimensions			Peso Weight Kg
		d mm	e mm	g mm	
SM 5	800	16	180	42	0,6
SM 7-8	2000	23	220	53	1,5
SM 10	3150	27	280	58	2,9
SM 13	5300	40	400	90	8,2
SM 16	8000	50	500	120	16
SM 19	11200	60	550	130	26



Tenditore KSS

KSS Clevis turnbuckle

- Per imbragare carichi pesanti su camion e treni.
- Per sollevamento è disponibile il modello con catena di sicurezza.
- For lashing and tying down heavy loads on truck.
- For lifting purposes, also available with additional securing chain.

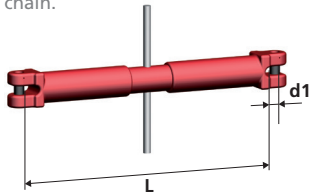

Tipo Type	Portata WLL	Regolazione Take up	Dimensioni Dimensions			Peso Weight
	Kg		mm	L min mm	L max mm	d1 mm
KSS 7	1500	90	230	320	8	2,90
KSS 8	2000	120	330	450	10	3,20
KSS 10	3150	215	455	670	12	3,90
KSS 13	5300	280	515	795	16	6,50
KSSW 16	10000	250	530	780	20	10,00

Gancio per balle e reti metalliche in rotoli BA

BA Bale and structural steel wire mesh hook

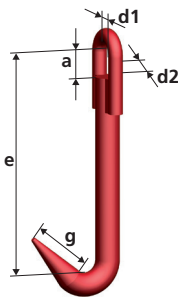

Tipo Type	Portata WLL	Dimensioni Dimensions					Peso Weight
		Kg	a mm	d1 mm	d2 mm	e mm	g mm
BA 5-6	1120	24	16	7	160	40	0,4
BA 7-8	2000	30	19	10	200	50	0,7
BA 10	3150	39	27	13	260	65	1,5

Gancio per fusti FA

FA Barrel hook

- Da utilizzare esclusivamente in coppia.
- Angolo inclinazione max 30°.
- Only for use in pairs.
- Angle of inclination: 30° max

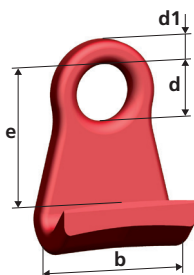

Tipo Type	Portata WLL	Dimensioni Dimensions				Peso Weight
		Kg	b mm	d mm	d1 mm	e mm
FA 5-6	500	70	40	17	90	0,8

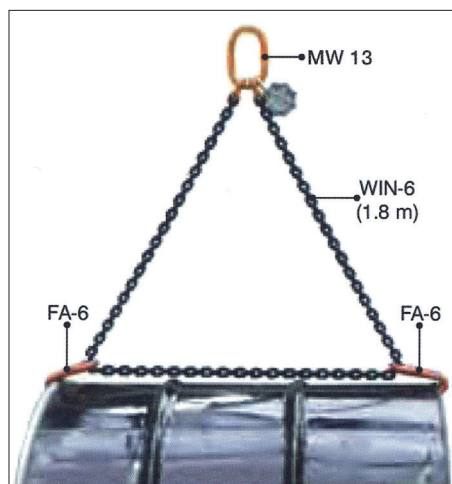

Sicurezza forgiata SFGW

SFGW Safety catch set



Tipo Type	Per gancio tipo For hook type		
SFGW 5-6	HSW 5-6	KHSW 5-6	
SFGW 7-8	HSW 7-8	KHSW 7-8	WSBW 7-8
SFGW 10	HSW 10	KHSW 10	WSBW 10
SFGW 13	HSW 13	KHSW 13	WSBW 13
SFGW 16	HSW 16	KHSW 16	
SFGW 19-20	HSW 19-20	KHSW 19-20	
SFGW 22	HSW 22	KHSW 22	
SFGW 26-32	HSW 26 / HSW 32		

Sicurezza forgiata SFGW-G

SFGW-G Safety catch set



Tipo Type	Per gancio tipo For hook type
SFGW-G 8	GKHSW 8
SFGW-G-10	GKHSW 10

Sicurezza forgiata SFGW-B

SFGW-B Safety catch set



Tipo Type	Per gancio tipo For hook type
SFGW-B 8	BKHSW 8
SFGW-B-10	BKHSW 10

Sicurezza VLHW per ganci autobloccanti

VLHW Safety catch set for self locking hooks

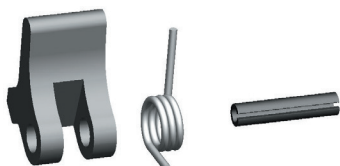

Tipo Type	Per gancio tipo For hook type		
VLHW 5-6	LHW 5-6	KLHW 5-6	WLHW 5-6
VLHW 7-8	LHW 7-8	KLHW 7 / KLHW 8	WLHW 7-8
VLHW 10	LHW 10	KLHW 10	WLHW 10
VLHW 13	LHW 13	KLHW 13	WLHW 13
VLHW 16	LHW 16	KLHW 16	WLHW 16
VLHW 19-20-22-26	LHW 19-20 / LHW 22	KLHW 19-20 KLHW 22 / KLHW 26	

Sicurezza PSGW per ganci accorciatori PSW e KPSW

PSGW Safety catch for PSW and KPSW grab hooks



Tipo Type	Per gancio tipo For hook type
PSGW 7/8	PSW 7/8, KPSW 7, KPSW 8
PSGW 10	PSW 10, KPSW 10
PSGW 13	PSW 13, KPSW 13
PSGW 16	PSW 16, KPSW 16

Perni e bussole CBHW per maglie di giunzione

CBHW Bolts and safety catch for connecting link



Tipo Type	Per maglie tipo For connex type
CBHW 5	CW 5
CBHW 6	CW 6
CBHW 7	CW 7
CBHW 8	CW8, CARW 8
CBHW 10	CW10, CARW 10
CBHW 13	CW13, CARW 13
CBHW 16	CW16, CARW 16
CBHW 19-20	CW 19-20
CBHW 22	CW22, CARW 22
CBHW 26	CW 26
CBHW 32	CW 32

Perni e spine KBSW per ganci a perno

KBSW Clevis load pins

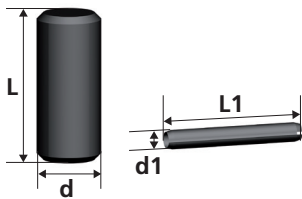

Tipo Type	Per gancio tipo For hook type						
KBSW 5-6	KHSW 5-6	KLHW 6		XKW 5-6	KPW 5-6		KRW 5-6
KBSW 7	KHSW 7	KLHW 7	KFW 7	XKW 7	KPW 7	KCHW 7	KRW 7
KBSW 8	KHSW 8	KLHW 8	KFW 8	XKW 8	KPW 8	KCHW 8	KRW 8
KBSW 10	KHSW 10	KLHW 10	KFW 10	XKW 10	KPW 10	KCHW 10	KRW 10
KBSW 13	KHSW 13	KLHW 13	KFW 13	XKW 13	KPW 13	KCHW 13	KRW 13
KBSW 16	KHSW 16	KLHW 16		XKW 16	KPW 16	KCHW 16	KRW 16
KBSW 19-20	KHSW 19-20	KLHW 19-20			KPW 19-20		KRW 19-20
KBSW 22	KHSW 22	KLHW 22			KPW 22		KRW 22
KBSW 26		KLHW 26					

Tipo Type	Dimensioni Dimensions				Peso Weight
	d mm	d1 mm	L mm	L1 mm	Kg
KBSW 5-6	7,4	2,5	16,5	16	0,006
KBSW 7	9,0	3,0	23,0	22	0,01
KBSW 8	10,0	3,0	23,0	22	0,01
KBSW 10	12,5	3,5	29,5	28	0,03
KBSW 13	16,0	4,0	37,0	36	0,06
KBSW 16	20,0	4,5	52,0	40	0,10
KBSW 19-20	24,0	5,0	73,0	50	0,20
KBSW 22	27,0	5,0	71,0	55	0,32
KBSW 26	33,0	5,0	86,0	55	0,58

Gancio comandato a distanza Pewag LEVO

Remote controller Pewag LEVO hook

The Pewag Levo hook is an innovative lifting device with a rotatable lifting hook.

The Levo hook is operated by radio control, ensuring the straightforward, safe and speedy handling of loads.

Loads no longer need to be attached and removed manually.

By interlinking several hooks, works processes may be simplified and stream-lined even further.

This innovative hook really comes into its own in extreme working conditions such as works performed at great heights, in construction pits or in extreme temperatures.

The Levo hook increases safety for workers, in particular during speedy work processes.

Critical situations are avoided thanks to automated loading and unloading.

Characteristics

- Up to 8000 operating cycles without a break, hook opens and closes within 2,5 seconds
- Safety factor against break 4:1
- Accidental opening of the hook under load is not possible
- Secured communication between hook and remote control
- Operating temperature: -20°C / 60°C
- Protection class: IP65 (except for the radio control)
- Frequency: 868 Mhz (Europe)
- Range: 100m

Pewag Levo è un innovativo dispositivo di sollevamento completo di gancio girevole.

Il gancio Levo viene azionato mediante radiocomando, garantendo una movimentazione dei carichi semplice, sicura e veloce.

Non è più necessario caricare e rimuovere i carichi manualmente.

Collegando diversi ganci i processi di lavoro possono essere semplificati e ridotti ulteriormente.

Il gancio Levo manifesta le sue caratteristiche in condizioni estreme quali i lavori a grandi altezze, nelle fosse di costruzione o in presenza di temperature critiche.

Il gancio Levo aumenta la sicurezza per gli operatori, in particolare durante i processi di lavoro rapidi. Situazioni critiche vengono evitate grazie al carico e allo scarico automatici.

Caratteristiche

- Fino a 8000 cicli di lavoro senza interruzioni, il gancio si apre e chiude in 2,5 secondi
- Coefficiente di sicurezza 4
- Impossibile apertura del gancio sottocarico
- Comunicazione sicura tra il radiocomando ed il gancio Levo
- Temperatura di impiego: -20°C / 60°C
- Grado di protezione: IP65 (ad eccezione del radiocomando)
- Frequenza di funzionamento: 868 Mhz (Europa)
- Distanza di comando: circa 100m

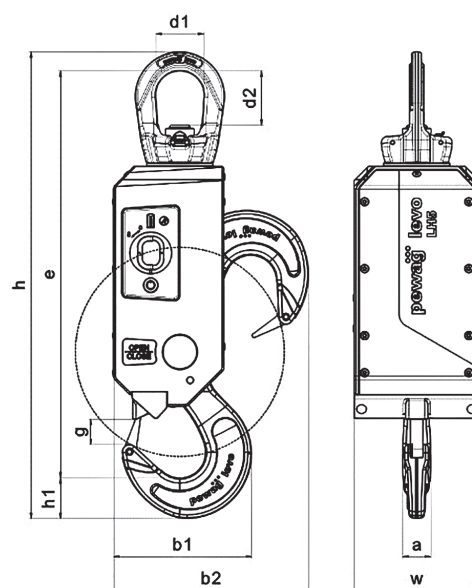

Codice Code	Portata WLL Kg	Dimensioni Dimensions										Peso Weight Kg
		a mm	b1 mm	b2 mm	d1 mm	d2 mm	e mm	g mm	h mm	h1 mm	w mm	
LH5	5000	32	156	220	54	61	460	29	528	46	142	20

Configurazione standard

Basis configuration



- Pratico radiocomando
- Practicable remote control

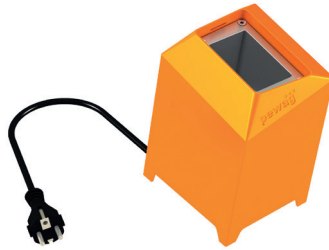

- Carica batterie
- Charging station



- Sensore di temperatura
- Equipped with temperature sensor

Optional

Optional equipment



- Modulo magnetico con sensore per il prelievo automatico del carico
- Magnetic module with sensor for automatic load pick-up



- Modulo di illuminazione - area di lavoro completamente illuminata
- Lighting module - fully illuminated working area

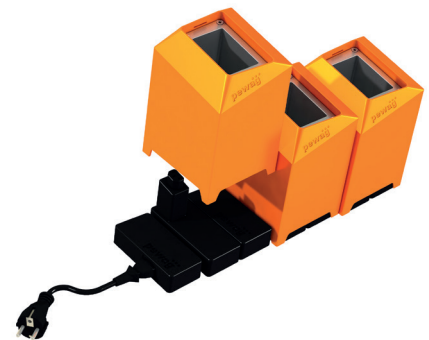

- Adattatore per il funzionamento contemporaneo di 10 carica batterie
- Multiloading adapter to operate up to 10 charging stations in one line

Applicazioni

Areas of application

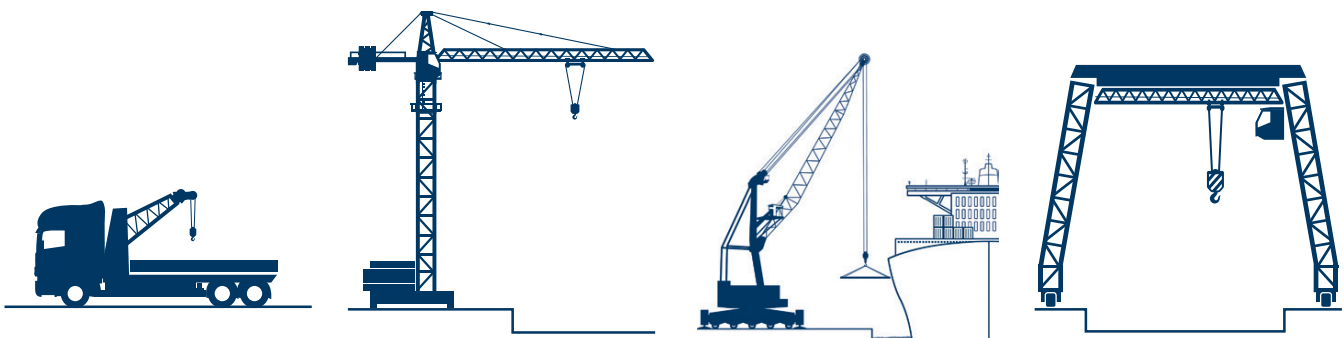

Catene e accessori - Grado 10

Chain and accessory system in G10

SISTEMA ANTICORROSIONE PEWAG CORROPRO

CORROSION PROTECTION
CORROPRO FROM PEWAG

CARATTERISTICHE SPECIFICATIONS

Corropro is an electrochemical anticorrosion coating, suitable for outdoor used slings, exposed to weathering of rain, sun and snow.

Outdoor weathering test

The chain was over 12 months exposed to weathering of rain, sun and snow. Beside a slight matt look of the surface, none erosion could be notice.

Corrosion protection values in comparison.

Salt spray test according to ISO 9227 (duration without corrosion of the base material respectively red dust)

Corropro	> 430 h
Powder coated	> 360 h
Electro galvanized 10 m	120 h
Varnished	24 h

Crosscut adhesion test method acc. To ISO 2409, DIN 53151, ASTM 3002.

The crosscut adhesion test provides information about the bond strength of Corropro on the surface. With crosscut significant value 0 Corropro shows optimal adhesion.

Pewag Corropro is not containing any heavy metals like lead, cadmium and hexavalent chromium.

Technical properties of the products are not influenced negatively. The coating process is free of hydrogen to the work piece. This is very important on products with high material strength over 1000 N/mm².

The colouring is black, similar to RAL 9005.
The size of the layer is about 20-25 micron.

Magnetic crack detection (Magnaflux process)

Pewag Corropro coated chains are able to be tested by magnetic crack detection without problem.

Corropro è un rivestimento elettrochimico anticorrosivo, indicato per proteggere catene utilizzate all'aperto, esposte a pioggia, sole e neve.

Test all'aperto

La catena è stata esposta per 12 mesi a pioggia, sole e neve.

Aldilà di una lieve opacatura sulla superficie, nessun segno di corrosione si è verificato.

Risultato della comparazione tra i differenti rivestimenti della catena.

Test in nebbia salina in accordo a ISO 9227 (durata senza corrosione della base del materiale.....)

Catena con rivestimento protettivo Corropro	> 430 h
Catena con verniciatura a polvere	> 360 h
Catena elettrozincata 10 um	120 h
Catena verniciata	24 h

Test di adesione con taglio a croce in accordo a ISO 2049, DIN 53151, ASTM 3002.

Il test di aderenza con taglio a croce permette di stabilire la forza di adesione del trattamento Corropro sulla catena e sugli accessori. Con valore di taglio 0 il trattamento Corropro ha denotato ottimi risultati.

Il trattamento Corropro non contiene nessun metallo pesante come il piombo, cadmio o cromo esavalente.

Le caratteristiche del prodotto non vengono influenzate negativamente dal trattamento superficiale. Il processo di rivestimento non prevede idrogeno, molto importante specialmente su catene con durezza elevate oltre 1000 N/mm².

Il colore finale è nero, simile a RAL 9005.

Lo spessore del rivestimento è di circa 20-25 um.

Rilevazione magnetica di cricche (Magnaflux)

Le catene Pewag con trattamento Corropro possono essere sottoposte a prove Magnaflux senza alcun problema.



TEST IN NEBBIA SALINA IN ACCORDO A ISO 9227

SALT SPRAY TEST TO ISO 9227 (NSS-TEST)



CONDIZIONI ORIGINALI
Rivestimento Corropro

STARTING SITUATION
Corropro protection

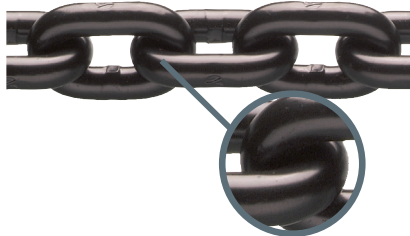

CONDIZIONI DOPO 528 H
La catena non presenta tracce di corrosione.

FINAL STATE AFTER 528 H
The chain doesn't show any trace of corrosion.



CONDIZIONI ORIGINALI
Verniciatura a polvere

STARTING SITUATION
Powder coated



CONDIZIONI DOPO 528 H
Si cominciano a vedere i primi segnali di corrosione della vernice.

FINAL STATE AFTER 528 H
The first signs of corrosion of the paints are noticed.



CONDIZIONI ORIGINALI
Catena elettrozincata 10 um

STARTING SITUATION
Electrogalvanized 10 um



CONDIZIONI DOPO 288 H
Piccoli punti di penetrazione dell'ossidazione con deterioramento dello strato di zinco.

FINAL STATE AFTER 288 H
Small penetration points of oxidation with deterioration of the zinc layer.



CONDIZIONI ORIGINALI
Catena verniciata

STARTING SITUATION
Varnished chain

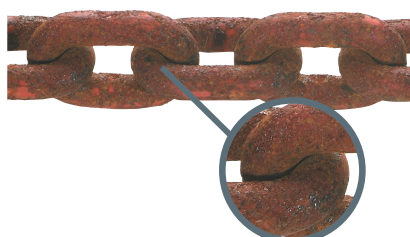

CONDIZIONI DOPO 168 H
Precoce deterioramento dello strato protettivo verniciato.

FINAL STATE AFTER 168 H
Early deterioration of the protective paint layer.

Catene e accessori Winner Pro - Grado 12

Winner Pro chain and
accessory system in G12

DATI TECNICI

TECHNICAL DATA

The higher working load limit (WLL) of the Pewag G12 program (50% more compared to G8 programs) allows significant weight reductions. Additionally, the profile of the chain improves the bending resistance of the chain.

TECHNICAL DATA

- Breaking elongation: **min 20%**
- Stress at load capacity limit: **300 N/mm²**
- Test stress: **750 N/mm²**
- Breaking stress: **1200 N/mm²**
- Bending: **0.8 x d**

Le portate superiori delle catene e degli accessori Pewag G12 (50% superiore alle catene G8) consentono notevoli riduzioni di peso dell'imbracatura, rendendone più facile l'utilizzo. Inoltre lo speciale profilo migliora la resistenza della catena alla curvatura.

DATI TECNICI

- Allungamento a rottura: **min. 20%**
- Sollecitazione al carico di lavoro: **300 N/mm²**
- Sollecitazione al carico di prova: **750 N/mm²**
- Sollecitazione alla rottura: **1200 N/mm²**
- Test di curvatura minimo: **0,8 x d**

MARCATURA

MARKING

Pewag G12 Winner Pro chains are available in following versions:

WINPRO Flex 200

Colour grey RAL 7045
Operating temperature: -40°C ÷ 200°C
Marking: "Pewag 12", "200"

WINPRO Flex 300

Colour RAL 5012
Operating temperature: -60°C ÷ 300°C (with load reduction)
Marking: "Pewag 12"

WINPRO Flex 300 PCP

Colour black with Corropro anticorrosion coating
Operating temperature: -60°C ÷ 300°C (with load reduction)
Marking: "Pewag 12"

Le catene Pewag grado 12 Winner Pro sono disponibili nelle seguenti versioni:

WINPRO Flex 200

Colore grigio RAL 7045
Temperatura di impiego: -40°C ÷ 200°C
Marcatura: "Pewag 12", "200"

WINPRO Flex 300

Colore RAL 5012
Temperatura di impiego: -60°C ÷ 300°C (con riduzione della portata)
Marcatura: "Pewag 12"

WINPRO Flex 300 PCP

Colore nero con rivestimento anticorrosione Corropro
Temperatura di impiego: -60°C ÷ 300°C (con riduzione della portata)
Marcatura: "Pewag 12"

PROFILO INTELLIGENTE

CLEVER PROFILE

The main characteristics of the chain, such as fatigue resistance and bending resistance were improved in a remarkable way. In order to reach the best mechanical performance, the material use was optimized on effective areas (blue area) and reduced on less relevant areas (red area).

Le principali caratteristiche della catena, quali la resistenza alla fatica e alla piegatura, sono state migliorate. L'impiego del materiale è stato ottimizzato nelle zone di contatto (blu) e ridotto nelle zone meno rilevanti (rosso), in modo da ottenere le migliori performance meccaniche.



RESISTENZA ALLA PIEGATURA OTTIMIZZATA

OPTIMIZED BENDING RESISTANCE

The section modulus which is important for preventing undesirable bending deformation is up to 6% higher with the profile chain compared to round steel chain with the same cross section. Therefore the max stress in the chain is reduced (red area).

La catena Winner Pro Flex G12 ha una sezione superiore fino al 6% rispetto alla corrispondente catena a maglie tonde. Di conseguenza lo stress sulla catena è ridotto (rosso).

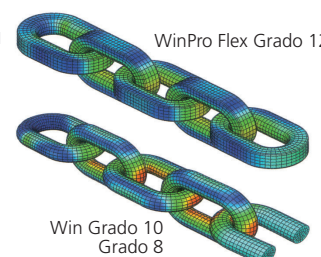

Catene e accessori Winner Pro - Grado 12

Winner Pro chain and
accessory system in G12

CARATTERISTICHE E VANTAGGI SPECIFICATION AND BENEFITS

Confronto tra le portate di imbragature G8, G10 e G12 G8, G10 and G12 chain slings load capacities comparison

Portata 50% superiore rispetto al grado 8 e 20% superiore rispetto al grado 10.
50% higher load capacity compared to G8, 20% higher load capacity compared to G10.

Portata WLL	Braca a 2 bracci G8/10 2 legs sling G8/10	Braca a 2 bracci G12 2 legs sling G12
Kg	Ø mm	Ø mm
4250	10	8
7100	13	10
11200	16	13

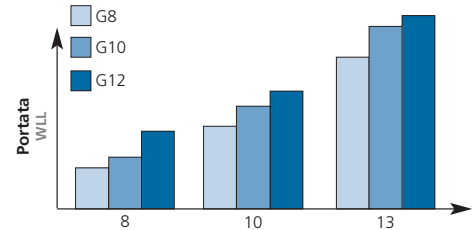

Confronto tra i pesi di imbragature G8 e G12 G8 and G12 chain slings weights comparison

Peso dell'imbragatura notevolmente inferiore rispetto a catene grado 8.
Weight of the chain sling lower compared to chains grade 8.

Portata WLL	Peso indicativo braca a 2 bracci L=3m - Grado 8 Weight of a 2 legs chain sling L=3m - Grade 8	Peso indicativo braca a 2 bracci L=3m - Grado 12 Weight of a 2 legs chain sling L=3m - Grade 12	Differenza di peso Weight difference
Kg	Kg	Kg	%
3350	16,6	9,4	44
4250	16,6	11,8	29
7100	28,5	19,20	33
11200	43,6	34,10	22

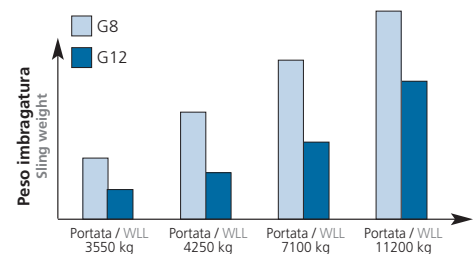

Catene e accessori Winner Pro - Grado 12

Winner Pro chain and
accessory system in G12

LIMITAZIONI ALL'USO DELLE BRACHE DEMANDING CONDITIONS

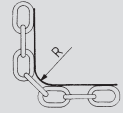
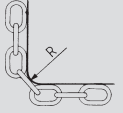
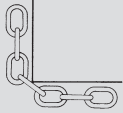
Temperatura Temperature	-60°C ÷ -40°C	-40°C ÷ 200°C	> 200°C ÷ 300°C	> 300°C
Fattore di carico Load factor WINPRO FLEX 200	Non ammissibile. Not permissible.	1	Non ammissibile. Not permissible.	Non ammissibile. Not permissible.
Fattore di carico Load factor WINPRO FLEX 300	1	1	0,6	Non ammissibile. Not permissible.
Distribuzione asimmetrica del carico Asymmetric load distribution	<p>La portata della braca deve essere diminuita di un braccio. Nel caso di brache a 3-4 bracci, la portata sarà quella di una braca a 2 bracci della catena corrispondente. Nel caso di brache a 2 bracci, la portata sarà quella della braca ad un braccio. Se la distribuzione del carico non è chiara, considerare sempre la portata della braca ad 1 braccio.</p> <p>The capacity of the sling should be decreased to a leg. In the case of 3 - 4 legs slings, the capacity will be as a 2 legs sling of the corresponding chain. In the case of 2 legs slings, the capacity will be of 1 leg sling. If the distribution of the load is not clear, always consider the capacity of 1 leg sling.</p>			
Sollevamento con catena a contatto con spigoli Edge load	 R > 2 x Ø catena/chain	 R > Ø catena/chain	 R < Ø catena/chain	
Fattore di carico Load factor	1	0,7	0,5	
Shock	Shock leggero Slight shock	Shock medio Medium shock	Shock pesante Heavy shock	
Fattore di carico Load factor	1	0,7	Non ammissibile Not permissible	



Catene e accessori Winner Pro - Grado 12

Winner Pro chain and
accessory system in G12

PORTATA DELLE IMBRAGATURE LOAD CAPACITIES

Coefficiente di sicurezza 4 Safety factor 4	1 braccio 1 leg		2 bracci 2 legs				3 e 4 bracci 3 and 4 legs		3 e 4 bracci con distributore di carico 3 and 4 legs with load distributor		Anello continuo Endless chain sling	Imbragatura a canestro Loop chains				
Angolo β Angle β	-	-	0°-45°	45°-60°	0°-45°	45°-60°	0°-45°	45°-60°	0°-45°	45°-60°	-	0°-45°	45°-60°	0°-45°	45°-60°	
Fattore di carico Load factor	1	0,8	1,4	1	1,12	0,8	2,1	1,5	2,8	2	1,6	1,4	1	2,1	1,5	
Catena tipo Chain type	d	Portata Kg WLL Kg														
WINPRO FLEX G12	7	2360	1900	3350	2360	2650	1900	5000	3550	6700	4750	3750	3350	2360	5000	3550
WIN G10	7	1900	1500	2650	1900	2120	1500	4000	2800	5300	3750	3000	2650	1900	4000	2800
WB G8	7	1500	1200	2120	1500	1700	1200	3150	2240	4000	3000	2500	2120	1500	3150	2240
WINPRO FLEX G12	8	3000	2360	4250	3000	3350	2360	6300	4500	8500	6000	4750	4250	3000	6300	4500
WIN G10	8	2500	2000	3550	2500	2800	2000	5300	3750	7100	5000	4000	3550	2500	5300	3750
WB G8	8	2000	1600	2800	2000	2240	1600	4250	3000	5600	4000	3150	2800	2000	4250	3000
WINPRO FLEX G12	10	5000	4000	7100	5000	5600	4000	10600	7500	14000	10000	8000	7100	5000	10600	7500
WIN G10	10	4000	3150	5600	4000	4250	3150	8000	6000	11200	8000	6300	5600	4000	8000	6000
WB G8	10	3150	2500	4250	3150	3550	2500	6700	4750	8500	6300	5000	4250	3150	6700	4750
WINPRO FLEX G12	13	8000	6300	11200	8000	9000	6300	17000	11800	-	-	12500	11200	8000	17000	11800
WIN G10	13	6700	5300	9500	6700	7500	5300	14000	10000	-	-	10600	9500	6700	14000	10000
WB G8	13	5300	4250	7500	5300	5900	4250	11200	8000	-	-	8500	7500	5300	11200	8000
WINPRO FLEX G12	16	12500	10000	17500	12500	14000	10000	26500	19000	-	-	20000	17500	12500	26500	19000
WIN G10	16	10000	8000	14000	10000	11200	8000	21200	15000	-	-	16000	14000	10000	21200	15000
WB G8	16	8000	6300	11200	8000	9000	6300	17000	11800	-	-	12500	11200	8000	17000	11800

Viene evidenziata la differenza di portata tra le catene WINNER PRO FLEX GRADO 12, WINNER GRADO 10 e le catene WB GRADO 8.
The table shows the different load capacities of WINNER PRO FLEX GRADE 12 sling chains compared to WINNER GRADE 10 and GRADE 8 WB chains.



Catene e accessori Winner Pro - Grado 12

Winner Pro chain and
accessory system in G12

Catena WINPRO FLEX 200

WINPRO FLEX 200 Lifting chain

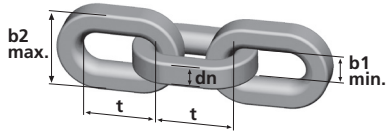

Tipo Type	Diametro nominale Nominal diameter dn mm	Passo Pitch t mm	Larghezza interna Inside width b1 min mm	Larghezza esterna Outside width b2 max mm	Portata WLL Kg	Carico di rottura Breaking force kN	Peso Weight Kg/m
WINPRO 7 FLEX 200	7	22	10	26	2360	92,60	1,36
WINPRO 8 FLEX 200	8	25	11	29	3000	118,00	1,64
WINPRO 10 FLEX 200	10	33	14	37	5000	196,00	2,70
WINPRO 13 FLEX 200	13	41	19	50	8000	314,00	4,80
WINPRO 16 FLEX 200	16	51	23	60	12500	491,00	7,17

- Temperatura di lavoro: $-40^{\circ}\text{C} \div 200^{\circ}\text{C}$.
- Temperature range: $-40^{\circ}\text{C} \div 200^{\circ}\text{C}$.

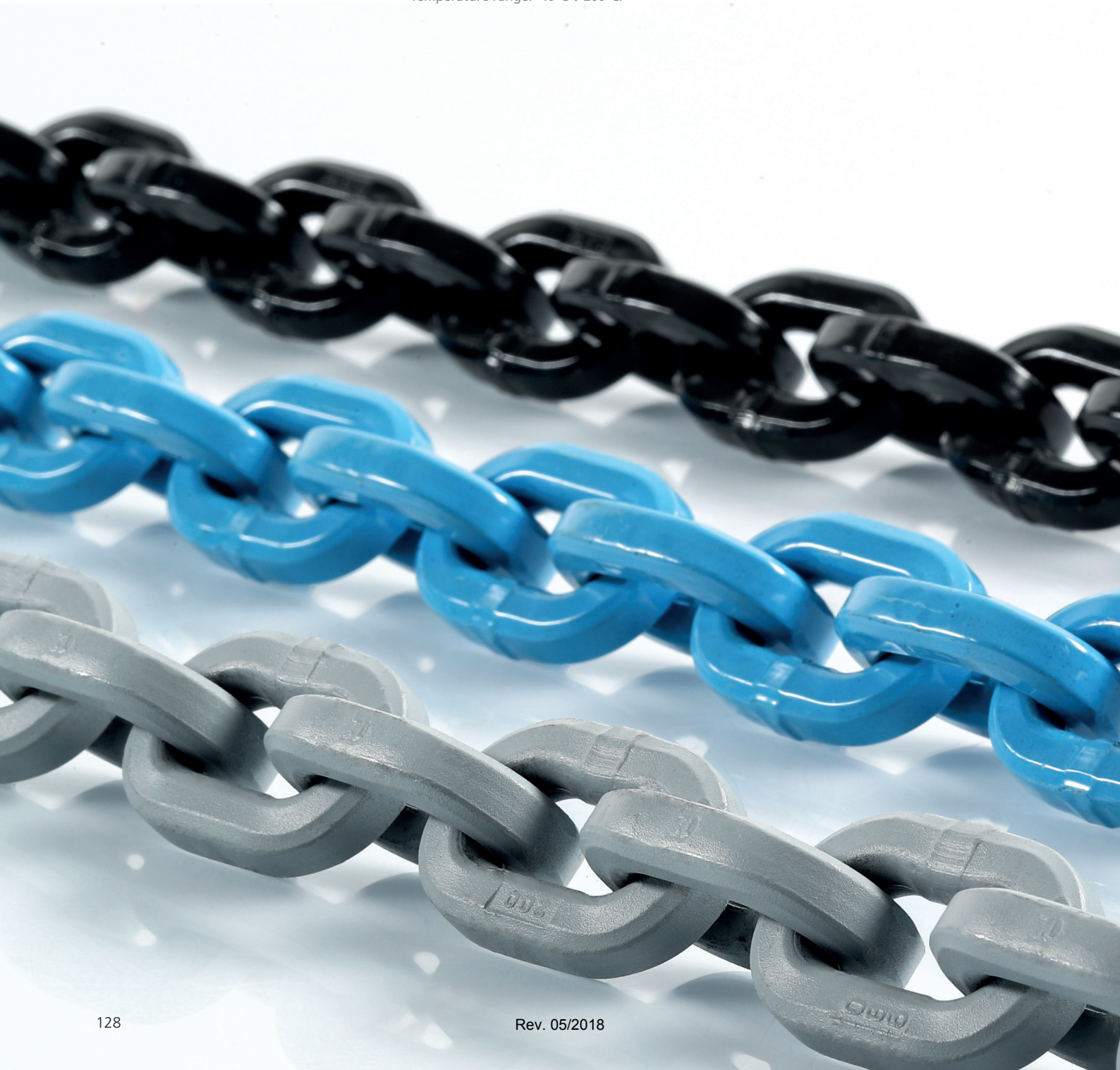

Catene e accessori Winner Pro - Grado 12

Winner Pro chain and
accessory system in G12

Catena WINPRO FLEX 300

WINPRO FLEX 300 Lifting chain

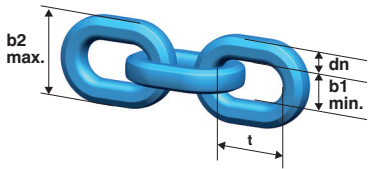

Tipo Type	Diametro nominale Nominal diameter dn mm	Passo Pitch t mm	Larghezza interna Inside width b1 min mm	Larghezza esterna Outside width b2 max mm	Portata WLL Kg	Carico di rottura Breaking force kN	Peso Weight Kg/m
WINPRO 7 FLEX 300	7	22	10	26	2360	92,60	1,36
WINPRO 8 FLEX 300	8	25	11	29	3000	118,00	1,64
WINPRO 10 FLEX 300	10	33	14	37	5000	196,00	2,70
WINPRO 13 FLEX 300	13	41	19	50	8000	314,00	4,80
WINPRO 16 FLEX 300	16	51	23	60	12500	491,00	7,17

- Temperatura di lavoro: $-60^{\circ}\text{C} \div 300^{\circ}\text{C}$.
- Temperature range: $-60^{\circ}\text{C} \div 300^{\circ}\text{C}$.

Catena WINPRO FLEX 300 CORROPRO

WINPRO FLEX 300 CORROPRO Lifting chain

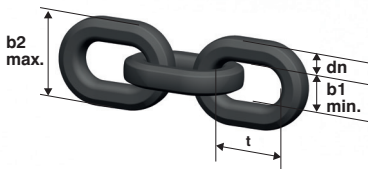

Tipo Type	Diametro nominale Nominal diameter dn mm	Passo Pitch t mm	Larghezza interna Inside width b1 min mm	Larghezza esterna Outside width b2 max mm	Portata WLL Kg	Carico di rottura Breaking force kN	Peso Weight Kg/m
WINPRO 7 FLEX 300 PCP	7	22	10	26	2360	92,60	1,36
WINPRO 8 FLEX 300 PCP	8	25	11	29	3000	118,00	1,64
WINPRO 10 FLEX 300 PCP	10	33	14	37	5000	196,00	2,70
WINPRO 13 FLEX 300 PCP	13	41	19	50	8000	314,00	4,80
WINPRO 16 FLEX 300 PCP	16	51	23	60	12500	491,00	7,17

- Temperatura di lavoro: $-60^{\circ}\text{C} \div 300^{\circ}\text{C}$.
- Temperature range: $-60^{\circ}\text{C} \div 300^{\circ}\text{C}$.



Catene e accessori Winner Pro - Grado 12

Winner Pro chain and
accessory system in G12

Campanella semplice AWP

AWP Master link

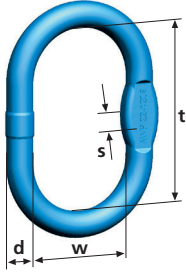

Tipo Type	Portata 0°-45° WLL 0°-45° Kg	Dimensioni Dimensions				Peso Weight Kg	Campanella per catena Ø Master link for chain Ø	
		d mm	t mm	w mm	s mm		1 br./leg mm	2 br./legs mm
AWP 13	2360	13	110	60	10	0,37	7	-
AWP 16	3500	17	110	60	14	0,55	8	7
AWP 18	5300	19	135	75	14	0,92	10	8
AWP 22	8000	23	160	90	17	1,60	13	10
AWP 27	12500	28	200	110	21	2,92	16	13
AWP 33	17500	33	200	110	21	4,14	-	16

Campanella maggiorata MWP

MWP Enlarged master link

- Per brache a 2 bracci utilizzare la campanella semplice AWP oppure la campanella tripla VMWP. La campanella MWP 36 può essere utilizzata per brache a 2 bracci con catena dia 16.
- For 2 legs chains slings use the AWP master link or the master link assembly VMWP. The master ring MWP36 can be assembled with two legs slings dia 16.

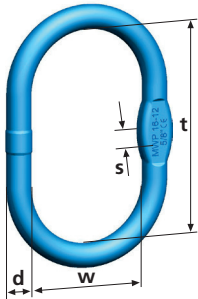

Tipo Type	Portata WLL Kg	Dimensioni Dimensions				Peso Weight Kg	Campanella per catena Ø Master link for chain Ø	
		d mm	t mm	w mm	s mm		1 br./leg mm	2 br./legs mm
MWP 13	2360	14	120	70	10	0,46	7	-
MWP 16	3200	17	140	80	13	0,74	8	-
MWP 18	5000	19	160	95	14	1,05	10	-
MWP 26	10100	27	190	110	20	2,47	13	-
MWP 36	17500	38	275	150	29	7,48	-	16

Campanella tripla VMWP

VMWP Master link assembly

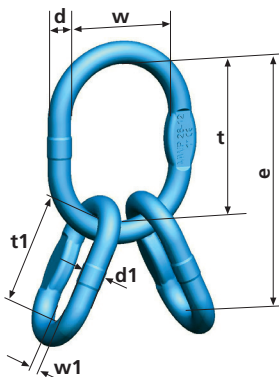

Tipo Type	Assemblaggio Consisting of	Portata 0°-45° WLL 0°-45° Kg	Dimensioni Dimensions							Peso Weight Kg	Campanella per catena Ø Master link for chain Ø	
			d mm	d1 mm	e mm	t mm	t1 mm	w mm	w1 mm		2 br./legs mm	3/4 br./legs mm
VMWP 7/8	MWP 18 +2 BWP 13	4250	19	13	214	160	54	95	25	1,55	7+8	-
VMWP 10/7/8	MWP 26 +2 BWP 16	8800	27	17	260	190	70	110	34	3,37	10	7+8
VMWP 13/10	MWP 32 +2 BWP 20	12300	33	20	315	230	85	130	40	6,00	13	10
VMWP 16/13	MWP 36 +2 BWP 26	21200	38	27	415	275	140	150	65	11,12	16	13
VMWP -/16	MWP 36 +2 BWP 32	26500	38	33	425	275	150	150	70	13,80	-	16

Catene e accessori Winner Pro - Grado 12

Winner Pro chain and
accessory system in G12

Campanella maggiorata VLWP 1

VLWP 1 Enlarged master link

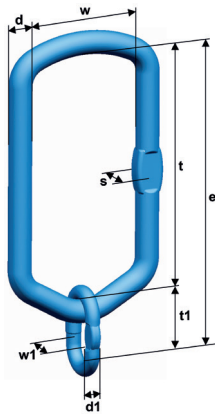

Tipo Type	Assemblaggio Consisting of	Portata WLL Kg	Dimensioni Dimensions								Peso Weight Kg	Campanella per catena Ø Master link for chain Ø 1 br./leg mm
			d mm	d1 mm	e mm	t mm	t1 mm	w mm	w1 mm			
VLWP 1-7/8	LWP 22 + BWP 13	3000	23	13	394	340	54	155	25	3,37	7+8	
VLWP 1-10	LWP 26 + BWP 16	5000	26	17	410	340	70	155	34	3,56	10	
VLWP 1-13	LWP 26	8000	28	-	340	340	-	155	-	4,40	13	
VLWP 1-16	LWP 33	12500	33	-	340	340	-	155	-	6,60	16	

Campanella maggiorata VLWP 2/4

VLWP 2/4 Enlarged master link

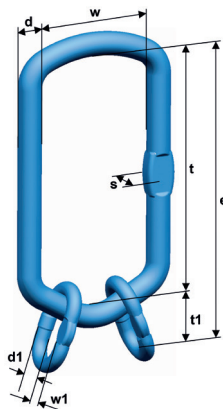

Tipo Type	Assemblaggio Consisting of	Portata 0°-45° WLL 0°-45° Kg	Dimensioni Dimensions								Peso Weight Kg	Campanella per catena Ø Master link for chain Ø	
			d mm	d1 mm	e mm	t mm	t1 mm	w mm	w1 mm	2 br./legs mm		3/4 br./legs mm	
VLWP 2-7/8	LWP 22 + 2 BWP 13	4250	23	13	394	340	54	155	25	3,60	7/8	-	
VLWP 2-10 / 4-7/8	LWP 26 + 2 BWP 16	7100	27	17	410	340	70	155	34	5,20	10	7/8	
VLWP 2-13 / 4-10	LWP 32 + 2 BWP 20	11200	33	20	425	340	85	155	40	8,00	13	10	
VLWP 4-13	LWP 36 + 2 BWP 26	17000	38	27	480	340	140	155	65	12,80	-	13	
VLWP 2-16	LWP 36	17500	38	-	340	340	-	155	-	8,90	16	-	
VLWP 4-16	LWP 40 + 2 BWP 32	26500	40	33	490	340	150	155	70	16,30	-	16	



Catene e accessori Winner Pro - Grado 12

Winner Pro chain and
accessory system in G12

Maglia di giunzione CWP

CWP Connecting link

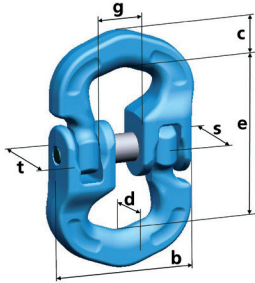

Tipo Type	Portata WLL Kg	Dimensioni Dimensions							Peso Weight Kg
		b mm	c mm	d mm	e mm	g mm	s mm	t mm	
CWP 7	2360	47	12	9	63	17	13	16	0,20
CWP 8	3000	58	14	10	62	21	15	20	0,30
CWP 10	5000	66	18	13	78	22	21	25	0,57
CWP 13	8000	84	22	17	107	26	25	34	1,24
CWP 16	12500	120	27	21	128	48	31	41	2,26

Gancio ad occhio HSWP

HSWP Eye sling hook

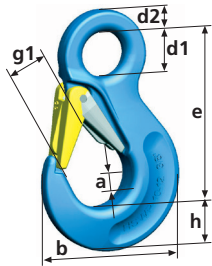

Tipo Type	Portata WLL Kg	Dimensioni Dimensions							Peso Weight Kg
		a mm	b mm	d1 mm	d2 mm	e mm	g1 mm	h mm	
HSWP 7/8	3000	19	88	25	11	106	26	27	0,50
HSWP 10	5000	26	108	34	16	131	31	33	1,10
HSWP 13	8000	33	132	43	19	164	39	43	2,20

Gancio autobloccante LHWP

LHWP Self locking hook

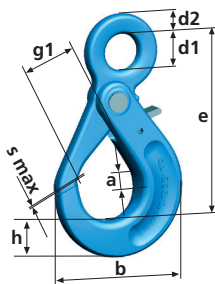

Tipo Type	Portata WLL Kg	Dimensioni Dimensions								Peso Weight Kg
		a mm	b mm	d1 mm	d2 mm	e mm	g1 mm	h mm	s max mm	
LHWP 7/8	3000	25	89	25	14	126	34	25	1	0,90
LHWP 10	5000	28	112	31	17	158	45	31	1,5	1,60
LHWP 13	8000	34	145	40	22	205	54	41	2	3,30

Catene e accessori Winner Pro - Grado 12

Winner Pro chain and
accessory system in G12

Gancio a perno KHSWP

KHSWP clevis sling hook

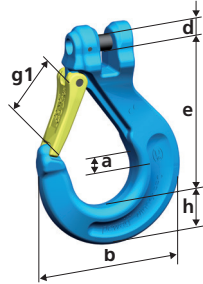

Tipo Type	Portata WLL Kg	Dimensioni Dimensions						Peso Weight
		a mm	b mm	d mm	e mm	g1 mm	h mm	Kg
KHSWP 7	2360	19	101	9,5	105	36	26	0,84
KHSWP 8	3000	19	101	10,7	105	36	26	0,84
KHSWP 10	5000	26	118	14	121	41	33	1,51
KHSWP 13	8000	30	147	17,5	148	49	43	2,85
KHSWP 16	12500	35	176	21	173	59	51	5,10

Gancio autobloccante a perno KLHWP

KLHWP Self locking clevis hook

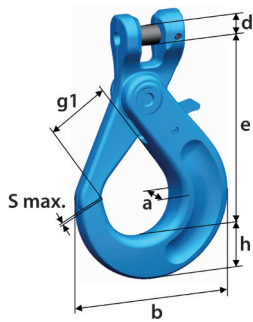

Tipo Type	Portata WLL Kg	Dimensioni Dimensions							Peso Weight
		a mm	b mm	d mm	e mm	g mm	h mm	s max mm	Kg
KLHWP 7	2360	23,60	90	9,50	116	32	24,50	1	0,89
KLHWP 8	3000	23,60	90	10,70	115	32	24,50	1	0,90
KLHWP 10	5000	27,80	113	14	136	45	31,50	1	1,60
KLHWP 13	8000	33,70	146	17,50	179	54	39,80	1,5	3,42

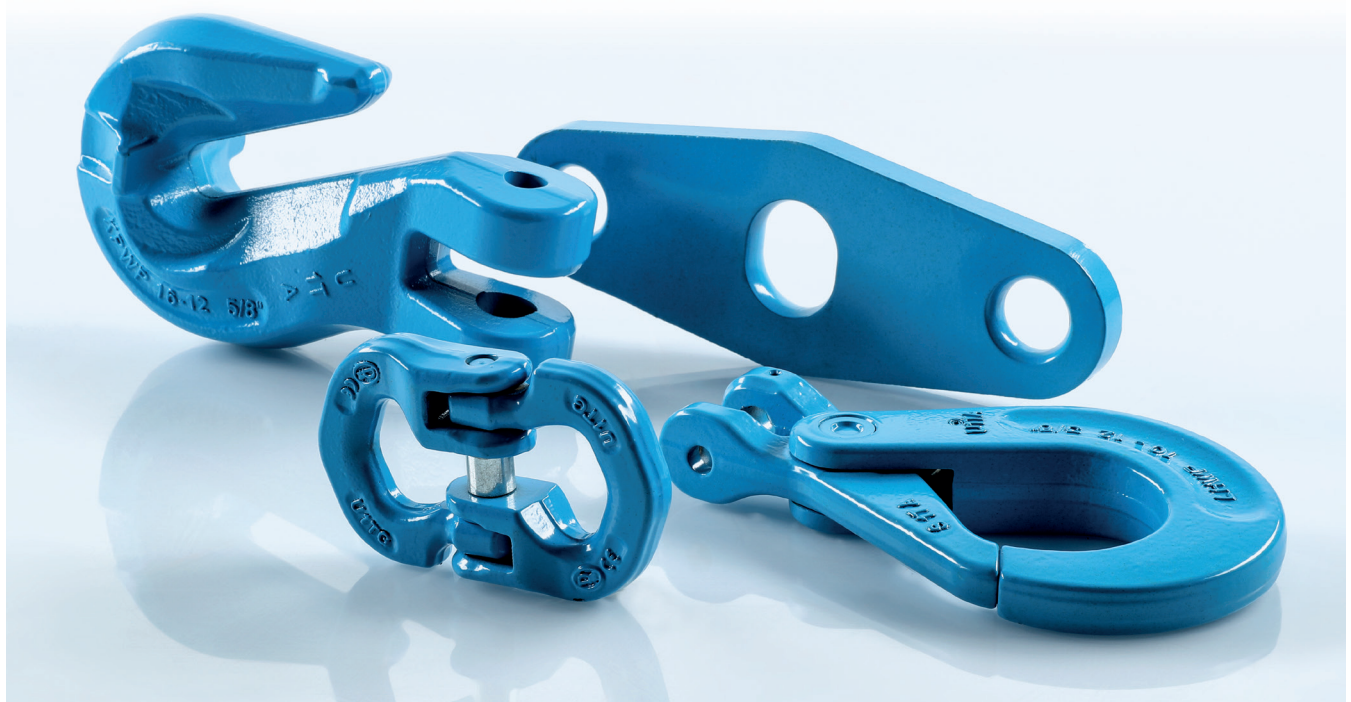

Catene e accessori Winner Pro - Grado 12

Winner Pro chain and
accessory system in G12

Gancio accorciatore PWP

PWP Grab hook

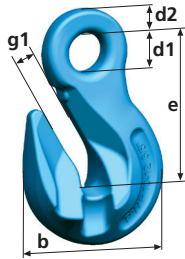

Tipo Type	Portata WLL Kg	Dimensioni Dimensions					Peso Weight Kg
		b mm	d1 mm	d2 mm	e mm	g1 mm	
PWP 7/8	3000	63	18	11	68	10	0,48
PWP 10	5000	81	22	14	88	13	1,03
PWP 13	8000	103	26	18	110	17	2,10

Gancio accorciatore PSWP con dispositivo di sicurezza

PSWP Grab hook with safety catch

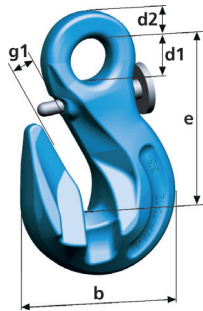

Tipo Type	Portata WLL Kg	Dimensioni Dimensions					Peso Weight Kg
		b mm	d1 mm	d2 mm	e mm	g1 mm	
PSWP 7/8	3000	63	18	11	68	10	0,48
PSWP 10	5000	81	22	14	88	13	1,03
PSWP 13	8000	103	26	18	110	17	2,10

Gancio accorciatore KPWP

KPWP Clevis grab hook

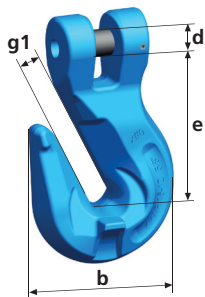

Tipo Type	Portata WLL Kg	Dimensioni Dimensions				Peso Weight Kg
		b mm	d mm	e mm	g1 mm	
KPWP 16	12500	123	21	124	19	4,32

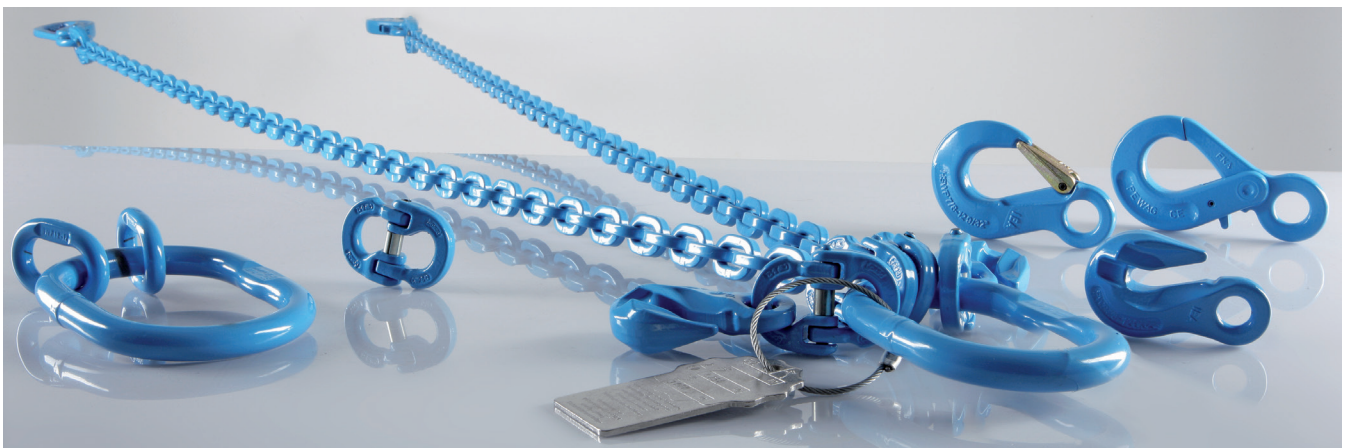

Catene e accessori Winner Pro - Grado 12

Winner Pro chain and
accessory system in G12

Distributore di carico AGWP Load distributor AGWP

The capacity of a 4 legs sling is considered as a 3 leg since it is assumed the load is supported by only three legs and the fourth-one is operating as an equalizer. AGWP load distributor allows to share the load on all the four legs and thus be able to establish a higher capacity for the sling.

Furthermore it is possible to use a smaller size in order to save on weight without minimizing the overall carrying capacity.

Given that the 4 legs sling with load distributor has a higher capacity compared to a standard 4 legs sling, pay attention to the choice of the master ring.

The AGWP load distributor is very compact and can be used up to 60° inclination.

If in time should occur signs of wear, the device can be turned by 180°, doubling the duration of use.

- Increased carrying capacity
- Usage up to 60° inclination angle
- Double the durability
- Improved wear resistance
- Quick and easy assembly

Convenzionalmente la portata di una braca a 4 bracci viene calcolata su solo 3 bracci, perchè si assume che il carico venga sostenuto da soli 3 bracci e che un braccio faccia da stabilizzatore.

Il distributore di carico AGWP consente di distribuire il carico su tutti i 4 bracci della braca e di conseguenza aumentare la portata dell'imbracatura. Questo consente anche di utilizzare un diametro inferiore di catena e accessori, riducendo il peso della braca, senza penalizzare la portata.

Il distributore di carico AGWP ha dimensioni estremamente compatte e può essere utilizzato fino a 60° gradi di inclinazione.

Se nel tempo si dovessero verificare dei segni di usura, il dispositivo può essere girato di 180° gradi raddoppiandone la durata di impiego.

- Portata superiore fino al 25%
- Utilizzo fino a 60° gradi di inclinazione tra i bracci
- Doppia durata di vita
- Resistenza alla fatica aumentata
- Assemblaggio facile e veloce

Tipo Type	Portata del distributore di carico AGWP WLL of load distributor AGWP		Dimensioni Dimensions						Maglia di accoppiamento* Connecting link*	Differenza L1/L2 (maglie di catena) Difference L1/L2 (chain links)	Peso Weight Kg
	0° - 45° Kg	45° - 60° Kg	a mm	e mm	d1 mm	d2 mm	h mm	h1 mm			
AGWP 7/8	4250	3000	210	51	22	25	15,5	14	CWP 10	n° 6 x Ø 7 mm n° 5 x Ø 8 mm	1,75
AGWP 10	7100	5000	180	32	25	32	23	15,5	CWP 13	4	1,56

• Coefficiente di sicurezza 4.

* Utilizzare questa maglia di accoppiamento per collegare il distributore di carico alla campanella.

• Safety factor 4

* Please use this connex to assemble the load distributor onto the master link assembly.

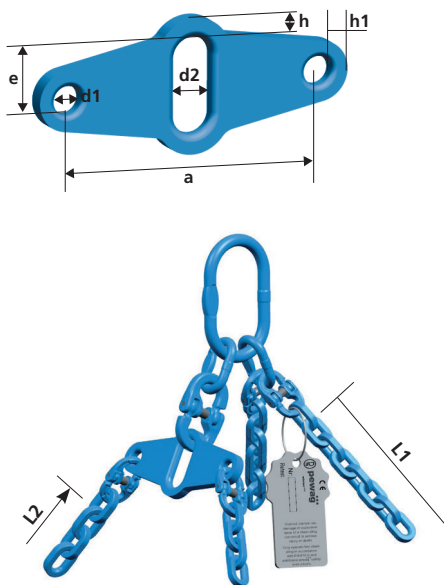

Coefficiente di sicurezza 4 Safety factor 4	Portate brache secondo EN 818 3 e 4 bracci WLL in according to EN 818 3 and 4 legs		Portate brache con distributore di carico 3 e 4 bracci WLL with load distributor 3 and 4 legs		
	Angolo β Angle β	0°-45°	45°-60°	0°-45°	45°-60°
Fattore di carico Load factor		2,1	1,5	2,8	2
Catena tipo Chain type	d	Portata Kg WLL Kg			
WINPRO 7 G12	7	5000	3550	6700	4750
WIN 7 G10	7	4000	2800	5300	3750
G8	7	3150	2240	4000	3000
WINPRO 8 G12	8	6300	4500	8500	6000
WIN 8 G10	8	5300	3750	7100	5000
G8	8	4250	3000	5600	4000
WINPRO 10 G12	10	10600	7500	14000	10000
WIN 10 G10	10	8000	6000	11200	8000
G8	10	6700	4750	8500	6300

Catene e accessori Winner Pro - Grado 12

Winner Pro chain and
accessory system in G12

Sicurezza forgiata SFGWP

SFGWP Safety catch set



Tipo Type	Per gancio tipo For hook type
SFGWP 7/8	HSWP 7/8
SFGWP 10	HSWP 10
SFGWP 13	HSWP 13

Sicurezza forgiata SFGWP-K

SFGWP-K Safety catch set



Tipo Type	Per gancio tipo For hook type
SFGWP-K 7/8	KHSWP 7 + KHSWP 8
SFGWP-K 10	KHSWP 10
SFGWP-K 13	KHSWP 13
SFGWP-K 16	KHSWP 16

Sicurezza VLHWP per ganci autobloccanti

VLHWP Trigger set for self looking hooks

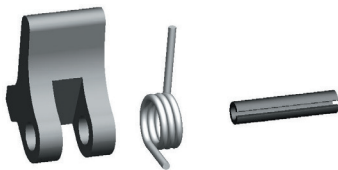

Tipo Type	Per gancio tipo For hook type
VLHWP 7/8	LHWP 7/8, KLHWP 7/8
VLHWP 10	LHWP 10, KLHWP 10
VLHWP 13	LHWP 13, KLHWP 13

Catene e accessori Winner Pro - Grado 12

Winner Pro chain and
accessory system in G12

Perni e spine KBSWP per ganci a perno

KBSWP Clevis load pins



Tipo Type	Per gancio tipo For hook type
KBSWP 7	KHSWP 7
KBSWP 8	KHSWP 8
KBSWP 10	KHSWP 10
KBSWP 13	KHSWP 13
KBSWP 16	KHSWP 16, KPWP 16

Perni e bussole CBHWP per maglie di giunzione

CBHWP Connex bolt and bushing set



Tipo Type	Per maglie tipo For connex type
CBHWP 7	CWP 7
CBHWP 8	CWP 8
CBHWP 10	CWP 10
CBHWP 13	CWP 13
CBHWP 16	CWP 16



DATI TECNICI

TECHNICAL DATA

The Ni-Cr-Mo steel chains meet the requirements of the EN 818 standards.

The boro steel manganese chains have the dimensional tolerances of the alloy steel chains, and they respect all parameters with the exception of the composition of the steel. Are guaranteed values of breaking elongation, to the breaking stress and consequently to the maximum working load.

TECHNICAL DATA

- Breaking elongation: **min 20%**
- Stress at load capacity limit: **200 N/mm²**
- Stress at load capacity limit: **500 N/mm²**
- Breaking stress: **800 N/mm²**

Le catene di acciaio legato al Ni-Cr-Mo e gli accessori sono prodotti in accordo ai requisiti delle Norme EN 818.

Le catene zincate in acciaio al boro manganese hanno le tolleranze dimensionali delle catene in acciaio legato, e ne rispettano tutti i parametri, ad eccezione della composizione dell'acciaio.

Sono garantiti i valori relativi all'allungamento a rottura, al carico di rottura e di conseguenza al carico massimo di utilizzo.

DATI TECNICI

- Allungamento a rottura: **min 20%**
- Sollecitazione al carico di lavoro: **200 N/mm²**
- Sollecitazione al carico di prova: **500 N/mm²**
- Sollecitazione alla rottura: **800 N/mm²**

MARCATURE

MARKING

The Grade 8 chains are marked with the symbol of identification of the manufacturer and the quality grade (8).

Each chain sling is marked with the number of identification of the lot production. All the chain sling are delivered complete with the identification tag and EC declaration of conformity.

Le catene di Grado 8 sono marcate con il simbolo di identificazione del produttore e il grado qualitativo (8).

Ogni catena è marcata con il numero di identificazione del lotto di produzione. Tutti i tiranti vengono consegnati completi di targhetta metallica di identificazione e dichiarazione di conformità CE.



PORTATA DELLE IMBRAGATURE

LOAD CAPACITIES

Coefficiente di sicurezza 4 Safety factor 4	1 braccio 1 leg		2 bracci 2 legs				3 e 4 bracci 3 and 4 legs		Anello continuo Endless chain sling	Imbragatura a canestro Loop chains				
Angolo β Angle β	-	-	0° - 45°	45° - 60°	0° - 45°	45° - 60°	0° - 45°	45° - 60°	0° - 45°	0° - 45°	45° - 60°	0° - 45°	45° - 60°	
Fattore di carico Load factor	1	0,8	1,4	1	1,12	0,8	2,1	1,5	1,6	1,4	1	2,1	1,5	
Catena tipo Chain type	Portata Kg WLL Kg													
WB 7	7	1500	1200	2120	1500	1700	1200	3150	2240	2500	2120	1500	3150	2240
WB 8	8	2000	1600	2800	2000	2240	1600	4250	3000	3150	2800	2000	4250	3000
WB 10	10	3150	2500	4250	3150	3550	2500	6700	4750	5000	4250	3150	6700	4750
WB 13	13	5300	4250	7500	5300	5900	4250	11200	8000	8500	7500	5300	11200	8000
WB 16	16	8000	6300	11200	8000	9000	6300	17000	11800	12500	11200	8000	17000	11800
WB 20	20	12500	10000	17000	12500	14000	10000	26500	19000	20000	17500	12500	26200	18700
WB 22	22	15000	12000	21200	15000	17000	12000	31500	22400	23600	21200	15000	31500	22400
WB 26	26	21200	16950	30000	21200	23700	16950	45000	31500	33500	30000	21200	45000	31500
WB 32	32	31500	25200	45000	31500	35200	25200	67000	47500	50000	45000	31500	67000	47500
WB 40	40*	50000	40000	71000	50000	56000	40000	106000	75000	80000	56000	40000	85000	60000
WB 45	45*	63000	50000	90000	63000	71000	50000	132000	95000	100000	71000	50000	106000	75600

* Disponibili solo in versione saldata.

* Available only in welded version.

LIMITAZIONI ALL'USO DELLE BRACHE

DEMANDING CONDITIONS

Se l'imbragatura è sottoposta a temperature estreme, carichi asimmetrici o a spigoli vivi, è necessario ridurre i valori indicati in tabella, utilizzando i fattori sotto riportati.

If the chain slings are used in severe conditions, as high temperatures, asymmetric load distribution or sharp edges, the maximum load capacity values must be reduced by the load factor below.

Temperatura Temperature	-40°C ÷ 200°C	200°C ÷ 300°C	300°C ÷ 400°C
Fattore di carico Load factor	1	0,9	0,75
Distribuzione asimmetrica del carico Asymmetric load distribution	<p>La portata della braca deve essere diminuita di un braccio. Nel caso di brache a 3-4 bracci, la portata sarà quella di una braca a 2 bracci della catena corrispondente. Nel caso di brache a 2 bracci, la portata sarà quella della braca ad un braccio. Se la distribuzione del carico non è chiara, considerare sempre la portata della braca ad 1 braccio.</p> <p>The capacity of the sling should be decreased to a leg. In the case of 3 - 4 legs slings, the capacity will be as a 2 legs sling of the corresponding chain. In the case of 2 legs slings, the capacity will be of 1 leg sling. If the distribution of the load is not clear, always consider the capacity of 1 leg sling.</p>		
Sollevamento con catena a contatto con spigoli Edge load			
Fattore di carico Load factor	1	0,7	0,5
Shock	Shock leggero Slight shock	Shock medio Medium shock	Shock pesante Heavy shock
Fattore di carico Load factor	1	0,7	Non ammissibile Not permissible

Quando la catena viene avvolta su carichi tondi, il diametro del tondo deve essere almeno 3 volte il passo della catena. In caso contrario, la portata della braca deve essere ridotta del 50%.

When lifting with chains on lugs or on round loads, it is recommended to use a lug diameter of at least 3 x the pitch of the chain. If this is not a case, the working load limit must be reduced by 50%.

CARATTERISTICHE

SPECIFICATION

ORDER TEXT

Specific information related to the capacity required, lifting points, uneven distribution of the load in case of more chain legs, angle between the legs of the sling, abnormal temperatures.

EXAMPLE OF ORDER

Chain sling - 13 mm - double-leg chain sling with master link and clevis hook - length 1.600 mm
Sling code: WB 2AKH 13 L= 1.600 MM

DATI NECESSARI PER L'ORDINE

N° dei bracci, Dimensione della catena, Tipo di catena.
Informazioni particolari inerenti la portata totale richiesta, distribuzione non uniforme del carico nel caso di tiranti a più bracci, ampiezza dell'angolo tra i bracci di catena, temperature anormali.

Esempio di ordine

Tirante di catena D 13 mm, a 2 bracci, con campanella e 2 ganci a perno alle estremità, lunghezza L = 1600 mm.
Codice del tirante: WB 2AKH 13 L = 1600 mm.



I codici in **nero** indicano accessori terminali a occhio.
Black codes mean eye type bottom hooks



I codici in **blu** indicano accessori terminali a perno.
Blue codes mean clevis type bottom hooks



Catene e accessori - Grado 8

Chain and accessory system in G8

BRACHE DI CATENA STANDARD

STANDARD CHAIN SLINGS

WB 1AH
WB 1AKH

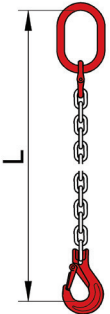

WB 2AH
WB 2AKH

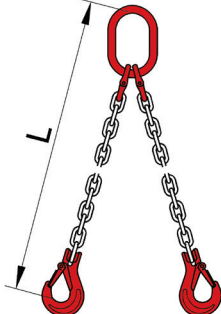

WB 3AH
WB 3AKH

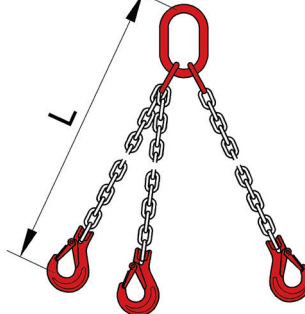

WB 4AH
WB 4AKH

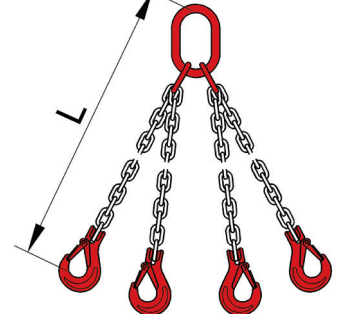

WB 1ALH
WB 1AKLH

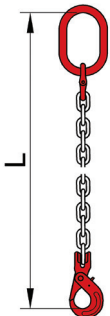

WB 2ALH
WB 2AKLH

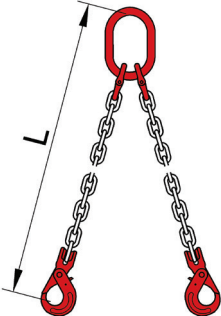

WB 3ALH
WB 3AKLH

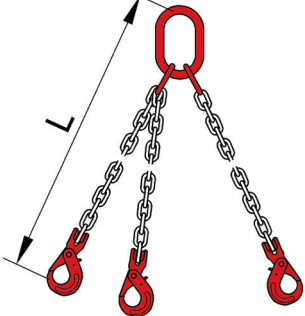

WB 4ALH
WB 4AKLH

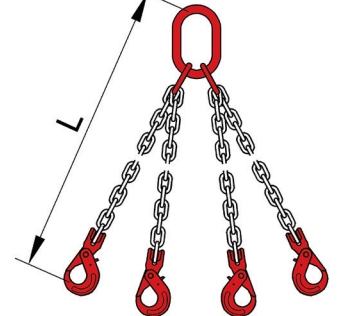

WB 1AHP
WB 1AKHP

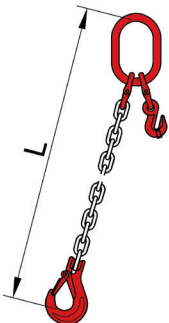

WB 2AHP
WB 2AKHP

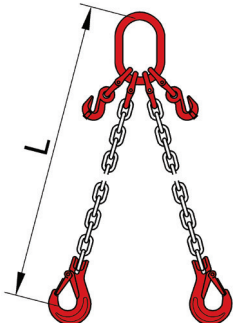

WB 3AHP
WB 3AKHP

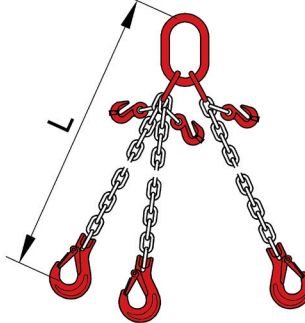

WB 4AHP
WB 4AKHP

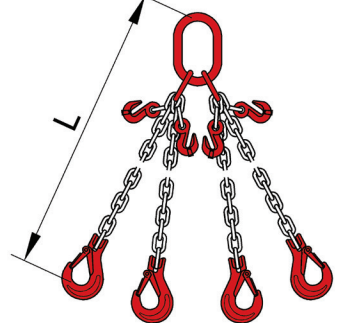

WB 1ALHP
WB 1AKLHP

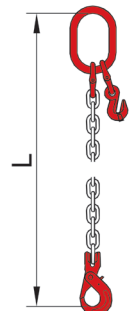

WB 2ALHP
WB 2AKLHP

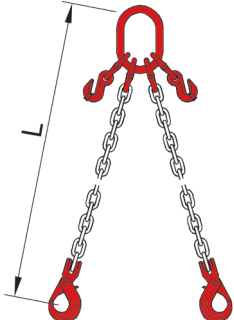

WB 3ALHP
WB 3AKLHP

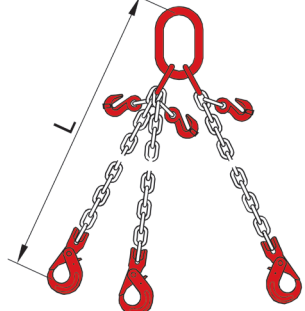

WB 4ALHP
WB 4AKLHP

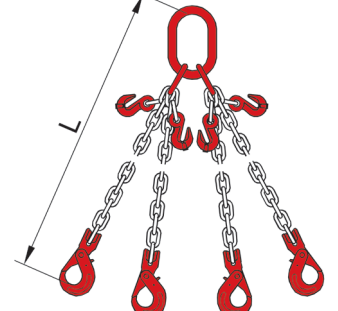

BRACHE DI CATENA E ACCESSORI
CHAIN SLINGS AND ACCESSORIES

Catene e accessori - Grado 8

Chain and accessory system in G8

Catena G8 tipo WB - Caratteristiche tecniche

G8 chain WB type - Technical data

Coefficiente di sicurezza 4:1
Safety factor 4:1

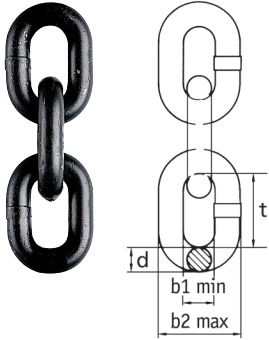

Tipo Type	Diametro nominale Nominal diameter d mm	Passo Pitch t mm	Larghezza Width		Portata WLL Kg	Carico di rottura Breaking force kN	Peso Weight Kg/m
			b1 min. mm	b2 max mm			
WB 7	7	21	9,1	25,9	1500	61,6	1,1
WB 8	8	24	10,4	29,6	2000	80,4	1,4
WB 10	10	30	13	37	3150	126	2,2
WB 13	13	39	16,9	48,1	5300	212	3,8
WB 16	16	48	20,8	59,2	8000	322	5,7
WB 20	20	60	26	74	12500	503	9
WB 22	22	66	28,6	81,4	15000	608	10,9
WB 26	26	78	33,8	96,2	21200	849	15,2
WB 32	32	96	41,6	118	31500	1290	23
WB 36	36	108	46,8	133	40000	1600	29
WB 40	40	120	52	148	50000	2000	36
WB 45	45	135	58,5	167	63000	2540	45,5

Campanella maggiorata W

W Enlarged master link

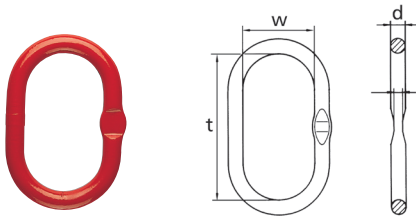

Tipo Type	Catena Chain 1 br. 2 br.		Portata WLL Kg	Dimensioni Dimensions			Peso Weight Kg
	Ø mm			d mm	t mm	w mm	
W 0807	8	7	2750	15	120	70	0,50
W 1008	10	8	3500	16	140	80	0,67
W 1310	13	10	5500	20	160	95	1,20
W 1613	16	13	9400	27	190	110	2,65
MW 32	20	16	16000	33	230	130	4,80
MW 36	22	20	21200	38	275	150	7,50
AW 45	26	22	30800	45	340	180	12,80
AW 50	32	26	40000	50	350	190	16,50
AW 56	-	32	64000	60	400	200	27,00

Campanella tripla WT

WT Enlarged master link assembly

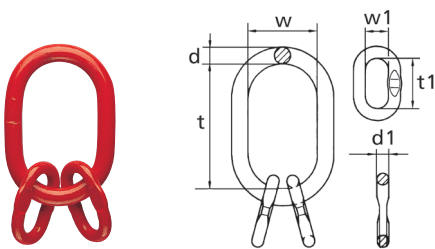

Tipo Type	Catena Chain 3/4 br. Ø mm	Portata WLL Kg	Dimensioni Dimensions						Peso Weight Kg
			d mm	d1 mm	w mm	w1 mm	t mm	t1 mm	
WT7	7	3150	19	13	75	25	135	54	1,16
WT8	8	4250	23	16	90	34	160	70	2,22
WT10	10	6700	27	18	100	40	180	85	3,36
WT13	13	11200	33	22	110	50	200	115	6,02
WT16	16	17000	36	26	140	65	260	140	9,94
VW 19-20	20	34100	50	33	190	70	350	150	22,8
VW 22	22	40000	50	36	190	75	350	170	25,1
VW 26	26	56000	60	40	200	80	400	170	41
V 32	32	76000	70	50	250	100	460	200	66

Catene e accessori - Grado 8

Chain and accessory system in G8

Maglia di giunzione CL

CL Connecting link

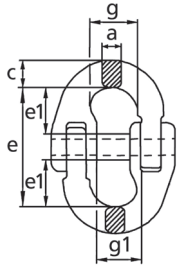

Tipo Type	Portata WLL Kg	Dimensioni Dimensions						Peso Weight Kg
		a mm	c mm	e mm	e1 mm	g mm	g1 mm	
CL 07	1500	8,8	10,5	51	20	20,5	17,8	0,10
CL 08	2000	9,5	12	61	25	23	19	0,25
CL 10	3150	12	12,5	72,5	30	27,5	23,8	0,35
CL 13	5300	17	20	88	36	33	28	0,68
CL 16	8000	20,5	22	103	40,5	39,5	34,3	1,10
CL 20	12500	23	23	116	48	47	44	1,70
CL 22	15000	26,5	26,5	133	51	55	49	2,20
CL 26	21200	31,5	31,5	148	60	66	60	4,20
CL 32	31500	37	37	183	69	79	67	7,19

Gancio ad occhio CA

CA Eye sling hook

- Con sicurezza forgiata.
- With forged safety latch.

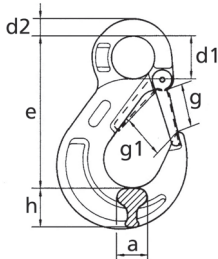

Tipo Type	Portata WLL Kg	Dimensioni Dimensions							Peso Weight Kg
		a mm	d1 mm	d2 mm	e mm	g mm	g1 mm	h mm	
CA 08	2000	19	25	11	95,5	29,5	24,5	27	0,50
CA 10	3150	23,5	34	14	120,5	35,7	29	33	0,90
CA 13	5300	29	42,5	17,5	150	43,5	35,4	40	1,50
CA 16	8000	35,5	52	22	183	52,5	44	49	2,75
CA 20	12500	42	62	25	217,5	60	54	55	4,50
CA 22	15000	51,5	60	30	224	70	62	60	7,10
HSW 26	21200	60	70	35	237	77	73	75	12,00
HS 32	31500	78	66	42	299	87	82	89	22,40

Gancio autobloccante CRO

CRO Self locking hook

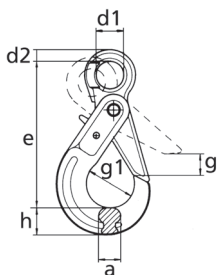

Tipo Type	Portata WLL Kg	Dimensioni Dimensions							Peso Weight Kg
		a mm	d1 mm	d2 mm	e mm	g mm	g1 mm	h mm	
CRO 08	2000	20	25	12	135	34	43	26	0,936
CRO 10	3150	25	33	16	168	45	56	30	1,626
CRO 13	5300	35	40	20	205	51	69	40	3,250
CRO 16	8000	36	50	27	251	60	80	50	6,050
CRO 20	12500	60	60	30	290	70	90	67	10,500
CRO 22	15000	62	70	32	322	80	100	70	14,400

Gancio accorciatore CD

CD Grab hook

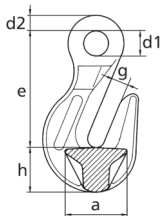

Tipo Type	Portata WLL Kg	Dimensioni Dimensions						Peso Weight Kg
		a mm	d1 mm	d2 mm	e mm	g mm	h mm	
CD 08	2000	30	16	10	60	10	24	0,23
CD 10	3150	44	21	11	80	13	31	0,59
CD 13	5300	53	26	16	104	17	38	1,24
CD 16	8000	64	30	19	129	20	60	2,6
CD 20	12500	85	36	22	153	23	65	4,2
CD 22	15000	87	38	25	180	27	68	5,3
CD 26	21200	100	55	36	213	30	88	13,2

Gancio fonderia CY

CY Foundry hook

- Utilizzare esclusivamente nei casi consentiti dalla legge.
- To use only when allowed by law.

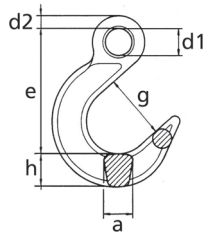

Tipo Type	Portata WLL Kg	Dimensioni Dimensions						Peso Weight Kg
		a mm	d1 mm	d2 mm	e mm	g mm	h mm	
CY 08	2000	25	18	13,5	125	64	29	0,92
CY 10	3150	23	32	14	150	76	30	1,77
CY 13	5300	38	27	19	173	89	40	2,82
CY 16	8000	45	47	24	210	102	48	5,03
CY 20	12500	54	56	28	260	114	60	7,6

Su richiesta disponibili fino a catena mm 26.
On request available till chain max 26 mm

Gancio a perno CB

CB Clevis sling hook

- Con sicurezza forgiata.
- With forged safety latch.

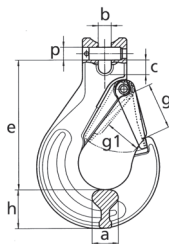

Tipo Type	Portata WLL Kg	Dimensioni Dimensions							Peso Weight Kg	
		a mm	b mm	c mm	e mm	g mm	g1 mm	h mm		p mm
CB 08	2000	19	8,7	9,8	86,3	29,5	25,5	27	9	0,53
CB 10	3150	23,5	12,2	13,5	105	35,7	30,5	33	13	0,95
CB 13	5300	28,5	15,3	17	128,5	43,5	41	40	16	1,67
CB 16	8000	37	18	22	155	56	45	48	20	3,00
CB 20	12500	46	23	26	183	61	52	52	24	5,70
CB 22	15000	50	24,5	29	213	72	62	62	27	8,80
CB 26	21200	60	30	34	230	77	73	75	30	13,5

Gancio autobloccante CRF

CRF Self locking hook

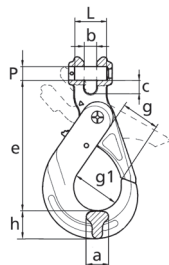

Tipo Type	Portata WLL Kg	Dimensioni Dimensions							Peso Weight Kg	
		a mm	b mm	c mm	e mm	g mm	g1 mm	h mm		PxL mm
CRF 7-8	2000	20	9	10	123	34	43	26	9x22,5	0,93
CRF 10	3150	25	12	14	143	45	56	30	13x31,5	1,58
CRF 13	5300	35	15	17	180	51	69	40	16x42	3,2
CRF 16	8000	36	19	20	215	60	80	50	21x51,5	5,9
CRF 20	12500	60	23	26	253	70	90	67	24x73	9,8
CRF 22	15000	62	26	32	287	80	100	70	26x72	14,4

Catene e accessori - Grado 8

Chain and accessory system in G8

Accorciatore CX con dispositivo di sicurezza

CX Grab hook with safety latch

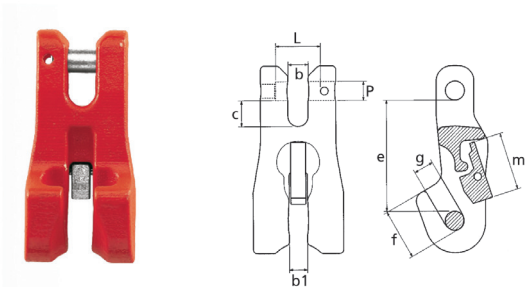

Tipo Type	Portata WLL Kg	Dimensioni Dimensions								Peso Weight Kg
		b mm	b1 mm	c mm	e mm	f mm	g mm	m mm	PxL mm	
CX 07S	1500	9,5	9,5	10	56	23,5	9,5	29	9x22,5	0,48
CX 08S	2000	9,5	9,5	10	56	23,5	9,5	29	10x22,5	0,48
CX 10S	3150	12	12	14,5	78	32,5	12	36	13x31,5	1,12
CX 13S	5300	15,5	15,5	18	90	44	15,8	35	16x42	1,83
CX 16S	8000	21	19	21	106	50	19	38	21x51,5	2,83

Gancio accorciatore CF

CF Clevis grab hook

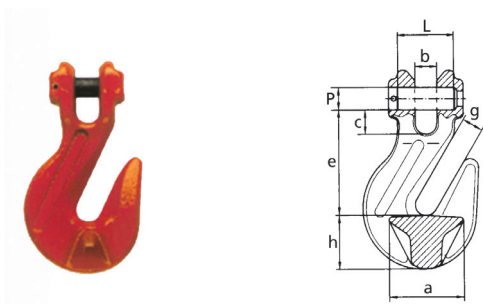

Tipo Type	Portata WLL Kg	Dimensioni Dimensions							Peso Weight Kg
		a mm	b mm	c mm	e mm	g mm	h mm	PxL mm	
CF 08	2000	30	9	10	50	10	24	9x22,5	0,27
CF 10	3150	44	13	14	72	13	31	13x31,5	0,75
CF 13	5300	53	17	17	88	17	38	16x42	1,35
CF 16	8000	64	21	20	111	20	60	21x61,5	2,8
CF 20	12500	85	24	24	130	24	65	24x61,5	4,8
CF 22	15000	87	26	26	139	26	68	26x72	5,65
CF 26	21200	100	30	35	190,5	30,5	90	30x80	13,5

Anello a omega CZ

CZ Coupling ring

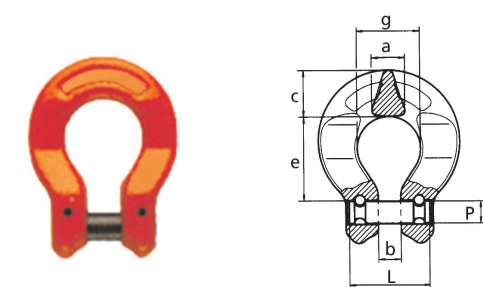

Tipo Type	Portata WLL Kg	Dimensioni Dimensions						Peso Weight Kg
		a mm	b mm	c mm	e mm	g mm	PxL mm	
CZ 08	2000	11	8,7	18	32	24	9x22,5	0,18
CZ 10	3150	14	12,5	19	44	32	13x31,5	0,35
CZ 13	5300	17	15	25	55	40	16x42	0,72
CZ 16	8000	22	19	30	65	50	21x61,5	1,20

Forcella CW

CW Clevis shackle

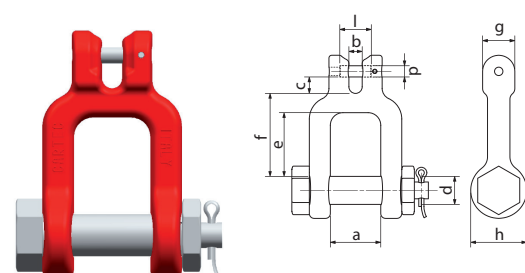

Tipo Type	Catena Chain mm	Portata WLL Kg	Dimensioni Dimensions								Peso Weight Kg	
			a mm	b mm	c mm	d mm	e mm	f mm	g mm	h mm		pxl mm
CW06	6	1120	36	9	11,5	20	45,5	59,5	23	40	8x22,5	0,8
CW08	7-8	2000	36	9	11	20	45,5	59,5	23	40	9x22,5	0,8

Catene e accessori - Grado 8

Chain and accessory system in G8

Gancio CJ per fasce di poliestere

CJ Hook for web slings

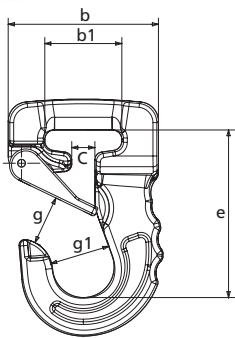

Colore fascia Web colour	Tipo Type	Portata WLL Kg	Dimensioni Dimensions										Peso Weight Kg
			a mm	a1 mm	b mm	b1 mm	c mm	e mm	g mm	g1 mm	h mm		
	CJ 01	1000	17	16	78	41	12	87	26	31	20	0,7	
	CJ 02	2000	21	17	91	55	19	105	31	40	26	1,2	
	CJ 03	3000	25	25	113	55	21	118	37	50	32	2,2	
	CJ 04	4000	36	36	133	70	40	147	43	59,5	40	4,5	
	CJ 05	5000	36	36	133	70	40	147	43	59,5	40	4,5	
	CJ 06	6000	36	36	133	70	40	147	43	59,5	40	4,5	
	CJ 08	8000	40	42	188	105	50	200	65	80	60	9,7	
	CJ 10	10000	40	42	188	105	50	200	65	80	60	9,7	

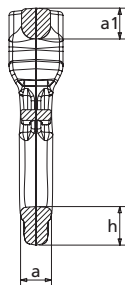

Maglia di giunzione CLS per brache di poliestere

CLS Connecting link for web slings

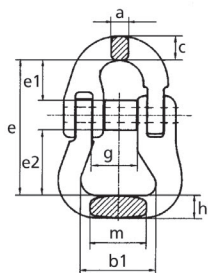

Tipo Type	Portata WLL Kg	Dimensioni Dimensions									Peso Weight Kg
		a mm	b1 mm	c mm	e mm	e1 mm	e2 mm	g mm	h mm	m mm	
CLS 08	2000	9	40	10	58	20	24	17	14	24	0,28
CLS 10	3150	11	40	13	81	30	35	23	14	30	0,47
CLS 13	5300	16	55	16	104	36	48	28	18	36	0,99
CLS 16	8000	21	67	21	115	40	57	36	24	44	2,0
CLS 20	12500	23	82	23	134	50	65	40	29	52	2,3
CLS 22	15000	27	125	27	177	59	100	43	39	68	3

Sicurezza forgiata CKS

CKS Safety catch set



Tipo Type	Accessori d'utilizzo Accessories of use		
CKS 08	CA 08	CB 08	CJ 01
CKS 10	CA 10	CB 10	CJ 02-03
CKS 13	CA 13	CB 13	CJ 04-05-06
CKS 16	CA 16	-	-
CKS 16B	-	CB 16	-
CKS 20	CA 20	CB 20	-
CKS 22	CA 22	CB 22	CJ 08-10
CKS 26	CA 26	CB 26	-

Sicurezza CKSL per ganci autobloccanti

CKSL Safety catch set for self locking hooks



Tipo Type	Accessori d'utilizzo Accessories of use	
CKSL 08	CRF 08	CRO 08
CKSL 10	CRF 10	CRO 10
CKSL 13	CRF 13	CRO 13
CKSL 16	CRF 16	CRO 16
CKSL 20	CRF 20	CRO 20
CKSL 22	CRF 22	CRO 22

Kit perno e spina CKP

CKP clevis load pin

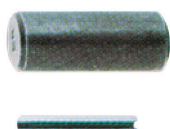

Tipo Type	Accessori d'utilizzo Accessories of use		
CKP 08	CB 08	CRF 08	SC 7-8
CKP 10	CB 10	CRF 10	SC 10
CKP 13	CB 13	CRF 13	SC 13
CKP 16	-	CRF 16	SC 16
CKP 16B	CB 16	-	-
CKP 20B	CB 20	CRF 20	-
CKP 22	CB 22	CRF 22	-
CKP 26	CB 26	-	-

Kit perno e bussola PSC per maglie di giunzione

PSC bolts and safety catch for connecting link



Tipo Type	Accessori d'utilizzo Accessories of use	
PSC 07	CL 07	
PSC 08	CL 08	CLS 08
PSC 10	CL 10	CLS 10
PSC 13	CL 13	CLS 13
PSC 16	CL 16	CLS 16
PSC 20	CL 20	CLS 20
PSC 22	CL 22	CLS 22
PSC 26	CL 26	-
PSC 32	CL 32	-

Catene e accessori di acciaio inossidabile - Grado 6

Stainless steel chain and accessory system in G6

DATI TECNICI

TECHNICAL DATA

- Stress at load capacity limit: **160 N/mm²**
- Breaking stress: **630 N/mm²**
- Breaking elongation: **Min. 20%**

MATERIAL

1.4571 (AISI 316 Ti), 1.4404 (AISI 316 L) and 1.4462 (AISI F51)

SURFACE

- Chain: Bright polished
- Components: Pickled and blasted

A wide range of chains and lifting components made of G6 stainless steel on which the mechanical value are based on a breaking tension of 630 N/mm.

BENEFITS

Increase in carrying capacity of G6 plus by approx 25% with the same nominal diameter as the G5; therefore more lifting capacity with similar weight.

Eye hooks made of G6 have higher lifting capacity in spite of larger hook mouth and narrower passage on the hook body for better fit in eyelets.

Master links larger dimensionated to fit optimally into large crane hooks.

FIELDS OF USE

- Water, wastewater and pump industry
- Chemical - and oil industry
- Clean technology and regenerative energy
- Food-, slaughterhouse, hygienic and fishing industry
- Powerplant and facilities (also in areas of higher temperatures)
- Surface treatment
- Marine and military
- Recreational and sport area

- Sollecitazione al carico di lavoro: **160 N/mm²**
- Sollecitazione alla rottura: **630 N/mm²**
- Allungamento a rottura: **min 20%**

MATERIALE

1.4571 (AISI 316 Ti), 1.4404 (AISI 316 L) e 1.4462 (AISI F51)

SUPERFICIE

- Catena: lucidata
- Accessori: decappati e sabbiati

Un programma completo di catene e accessori di acciaio inossidabile di grado 6 dove i valori meccanici sono basati su di una sollecitazione alla rottura di 630 N/mm.

VANTAGGI

25% circa di portata in più rispetto al grado 5 di uguale diametro; di conseguenza una portata superiore a parità di peso.

I ganci a occhio HSWI di grado 6 hanno portata superiore rispetto ai corrispondenti ganci inossidabili di grado 5, e presentano un'apertura della bocca superiore ed un profilo più ridotto per meglio adattarsi al punto di aggancio.

Campanelle di dimensioni maggiorate idonee anche per ganci larghi.

CAMPI DI IMPIEGO

- Acqua, acque reflue e pompe sommerse
- Industria petrolifera, tecnologie pulite e rinnovabili
- Alimentari, macelli, strutture igieniche e industrie del pesce
- Propulsori e strutture (anche in zone con temperature elevate)
- Trattamento di superfici
- Zone marine e militari
- Zone ricreative e sportive



PORTATA DELLE IMBRAGATURE

LOAD CAPACITIES

Coefficiente di sicurezza 4 Safety factor 4	1 braccio 1 leg		2 bracci 2 legs				3 e 4 bracci 3 and 4 legs		Anello continuo Endless chain sling	Imbragatura a canestro Loop chains				Imbragatura a U U-Shape	
Angolo β Angle β	-	-	0°-45°	45°-60°	0°-45°	45°-60°	0°-45°	45°-60°	-	0°-45°	45°-60°	0°-45°	45°-60°	-	
Fattore di carico Load factor	1	0,8	1,4	1	1,12	0,8	2,1	1,5	1,6	1,4	1	2,1	1,5	2	
Catena tipo Chain type	d	Portata Kg WLL Kg													
WOX 4-6	4	400	320	560	400	450	320	840	600	640	560	400	840	600	800
WOX 5-6	5	630	500	850	630	700	500	1300	940	1000	850	630	1300	940	1260
WOX 6-6	6	900	720	1250	900	1000	720	1850	1350	1400	1250	900	1850	1350	1800
WOX 7-6	7	1250	1000	1750	1250	1400	1000	2600	1850	2000	1750	1250	2600	1850	2500
WOX 8-6	8	1600	1280	2200	1600	1800	1280	3350	2400	2500	2220	1600	3350	2400	3200
WOX 10-6	10	2500	2000	3500	2500	2800	2000	5250	3750	4000	3500	2500	5250	3750	5000
WOX 13-6	13	4250	3400	5950	4250	4750	3400	8900	6350	6800	5950	4250	8900	6350	8500
WOX 16-6	16	6300	5040	8800	6300	7050	5040	13200	9400	10000	8800	6300	13200	9400	12600
WOX 20-5	20	8000	6400	11200	8000	-	-	-	-	12800	11200	8000	-	-	16000
WOX 26-4+	26	12000	9600	-	-	-	-	-	-	19200	-	-	-	-	24000

LIMITAZIONI ALL'USO DELLE BRACHE

DEMANDING CONDITIONS

When the chains are exposed to severe conditions (e.g. high temperatures, asymmetric load distribution, edge loading, impact/shock loads) the maximum working load limit value must be reduced according to the table below. If chains are wound around support arms or other round-shaped loads, the diameter should be minimum 3 times the chain pitch. For smaller diameters, the lifting capacity of the chains must be reduced by 50%. The stainless steel slings G6 should not be used with temperatures over 350°C. For applications with higher temperatures, we will gladly advise you.

Quando le brache sono soggette a severe condizioni di impiego (es alte temperature, carichi asimmetrici, carico su spigoli, shock) i valori massimi di portata devono essere ridotti come indicato nella tabella che segue. Se le brache vengono avvolte su dei perni o imbragano dei carichi di forma rotonda, il diametro degli stessi deve essere minimo 3 volte il passo della catena. In caso di diametri inferiori, la portata della braca deve essere ridotta del 50%. Le brache di catena grado 6 non possono essere impiegate in presenza di temperature superiori a 350°C. In caso di necessità, consultare FAS SpA.

Temperatura Temperature	-40°C ÷ 350°C	-40°C ÷ 350°C	> 350°C
Fattore di carico Load factor	1	1	Non ammissibile Not permissible
Distribuzione asimmetrica del carico Asymmetric load distribution	Il carico massimo di lavoro dell'imbragatura deve essere ridotto di almeno un braccio. In caso di dubbi, considerare la portata di un singolo braccio di catena. The WLL has to be reduced by at least 1 leg. In case of dubt only consider 1 leg as load-bearing.		
Sollevamento con catena a contatto con spigoli Edge load			
Fattore di carico Load factor	1	0,7	0,5
Shock	Shock leggero Slight shock	Shock medio Medium shock	Shock pesante Heavy shock
Fattore di carico Load factor	1	0,7	Non ammissibile Not permissible

Catene e accessori di acciaio inossidabile - Grado 6

Stainless steel chain and accessory system in G6

BRACHE DI CATENA STANDARD

STANDARD CHAIN SLINGS

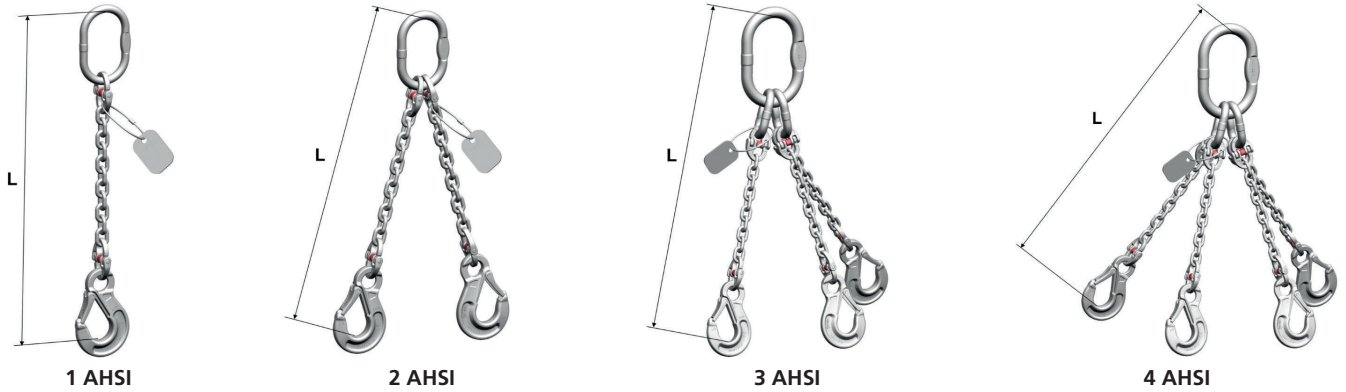

TARGA DI ACCIAIO INOSSIDABILE

ID IDENTIFICATION TAG

Undeattachable stainless steel identification tag and quick release fastener, corrosion resistant to solvents, acids, caustics and their vapours.

Pre stamped year dates make it immediately apparent when the last inspection took place; it is only necessary to stamp the month of the periodic inspection.

Targa e cordino di acciaio inossidabile resistenti a solventi, acidi, soda e ai vapori.

Incisi sul retro in modo progressivo gli anni per poter vedere facilmente quando è stata ispezionata la braca; è sufficiente punzonare il mese in cui è avvenuta l'ispezione.



Catena WOX

WOX Chain



Tipo Type	Diametro nominale Nominal diameter dn mm	Lunghezza standard Standard delivery length m	Passo Pitch t mm	Larghezza interna b1 min Inside width b1 min mm	Larghezza esterna b2 max Outside width b2 max mm	Portata WLL Kg	Carico di rottura Breaking force kN	Peso Weight Kg/m
WOX 4-6	4	50	12	6,2	14,8	400	16,0	0,40
WOX 5-6	5	50	15	7,5	18,5	630	25,0	0,61
WOX 6-6	6	50	18	8,7	20,9	900	37,5	0,88
WOX 7-6	7	50	21	9,5	25,2	1250	50,0	1,19
WOX 8-6	8	50	24	10,8	28,6	1600	63,0	1,53
WOX 10-6	10	50	30	13,5	36,0	2500	100,0	2,40
WOX 13-6	13	25	39	17,5	46,8	4250	170,0	4,05
WOX 16-6	16	25	48	21,5	57,6	6300	250,0	6,00
WOX 20-5	20	-	60	27,0	72	8000	314,0	9,29
WOX 26-4+	26	-	78	35,0	93,6	12000	471,0	16,20

Catene e accessori di acciaio inossidabile - Grado 6

Stainless steel chain and accessory system in G6

Campanella semplice AWI

AWI Master link

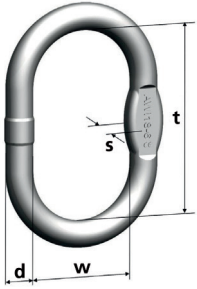

Tipo Type	Portata 0°-45° WLL 0°-45° Kg	Idonea per ganci DIN 15401 Can be used up to single hook acc. to DIN 15401 n°	Dimensioni Dimensions				Peso Weight Kg	Campanella per catena Ø Master link for chain Ø	
			d mm	t mm	w mm	s mm		1 br.	2 br.
AWI 8-6	560	0,5	8	60	35	-	0,08	4	4
AWI 10-6	850	1,6	10	80	50	-	0,14	5	5
AWI 13-6	1600	2,5	13	110	60	10	0,34	6/7/8	6
AWI 16-6	2600	2,5	16	110	60	14	0,53	10	7/8
AWI 18-6	3500	5	19	135	75	14	0,92	-	10
AWI 22-6	6300	6	23	160	90	17	1,60	13/16	13
AWI 26-6	8900	8	27	180	100	20	2,46	20	16
AWI 32-6	13200	10	32	200	110	26	4,14	-	20
AWI 36-6	14700	16	36	260	140	29	6,22	-	-
AWI 45-5	12000	25	45	340	180	-	12,82	26	-

Campanella tripla VWI

VWI Master link assembly

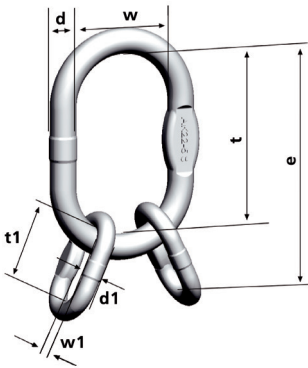

Tipo Type	Portata 0°-45° WLL 0°-45° Kg	Assemblaggio Consisting of	Idonea per ganci DIN 15401 Can be used up to single hook acc. to DIN 15401 n°	Dimensioni Dimensions							Peso Weight Kg
				d mm	d1 mm	e mm	t mm	t1 mm	w mm	w1 mm	
VWI 4-6	840	AWI 10-6 + 2 BWI 9-6	1,6	10	9	124	80	44	50	20	0,28
VWI 5-6	1300	AWI 13-6 + 2 BWI 10-6	2,5	13	10	154	110	44	60	20	0,52
VWI 6/7-6	2600	AWI 16-6 + 2 BWI 13-6	5	16	13	164	110	54	60	25	0,91
VWI 8-6	3350	AWI 18-6 + 2 BWI 20-6	6	18	16	205	135	70	75	34	1,64
VWI 10-6	5250	AWI 22-6 + 2 BWI 20-6	8	23	20	245	160	85	90	40	3,02
VWI 13-6	8900	AWI 26-6 + 2 BWI 22-6	10	27	23	295	180	115	100	50	4,78
VWI 16-6	13200	AWI 32-6 + 2 BWI 26-6	16	32	27	340	200	140	110	65	7,98



Catene e accessori di acciaio inossidabile - Grado 6

Stainless steel chain and accessory system in G6

Anello di transizione BWI

BWI Transition link

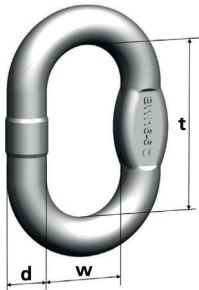

Tipo Type	Portata 0°-45° WLL 0°-45° Kg	Dimensioni Dimensions				Peso Weight Kg	Campanella per catena Ø Master link for chain Ø	
		d mm	t mm	w mm	s mm		1 br.	2 br.
BWI 7-6	900	7	36	16	-	0,03	5-6	5/6
BWI 9-6	1250	9	44	20	-	0,07	7	7
BWI 10-6	1600	10	44	20	-	0,09	8	8
BWI 13-6	2500	13	54	25	10	0,19	10	10
BWI 16-6	4250	16	70	34	14	0,36	13	13
BWI 20-6	6300	20	85	40	16	0,71	16	16
BWI 22-6	8000	23	115	50	17	1,16	20	-
BWI 26-6	10070	27	140	65	20	1,92	-	-
BWI 32-6	12000	32	150	70	26	3,18	26	-

Campanella tripla VAWI per brache di fune

VAWI Master link assembly for wire rope slings

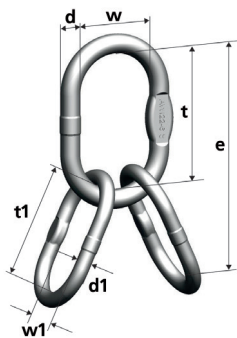

Tipo Type	Portata 0°-45° WLL 0°-45° Kg	Assemblaggio Consisting of	Idonea per ganci DIN 15401 Can be used up to single hook acc. to DIN 15401 n°	Dimensioni Dimensions							Peso Weight Kg
				d mm	d1 mm	e mm	t mm	t1 mm	w mm	w1 mm	
VAWI 6-6	1850	AWI 16-6 + 2 AWI 13-6	2,5	16	13	220	110	110	60	60	1,21
VAWI 7/8-6	3350	AWI 18-6 + 2 AWI 16-6	5	18	16	245	135	110	75	60	1,98
VAWI 10-6	5250	AWI 22-6 + 2 AWI 22-6	6	23	23	320	160	160	90	90	4,80
VAWI 13-6	8900	AWI 26-6 + 2 AWI 26-6	8	27	27	360	180	180	100	100	7,38
VAWI 16-6	13200	AWI 32-6 + 2 AWI 32-6	10	32	32	400	200	200	110	110	12,42



Catene e accessori di acciaio inossidabile

Stainless steel chain and accessory system

Maglia di giunzione CWI

CWI Connecting link

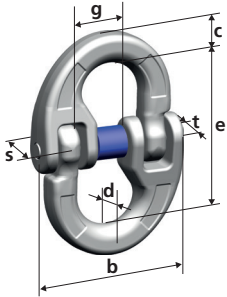

Tipo Type	Portata WLL Kg	Dimensioni Dimensions							Peso Weight Kg
		b mm	c mm	d mm	e mm	g mm	s mm	t mm	
CWI 5-6	630	34	7	7	36	13	10	11	0,06
CWI 6-6	900	40	8	7	42	13	11	12	0,08
CWI 7-6	1250	51	9	9	54	17	13	14	0,14
CWI 8-6	1600	51	10	8,5	58	17	13	14	0,16
CWI 10-6	2500	70	13	13	73	25	18	18	0,37
CWI 13-6	4250	86	17	17	92	29	23	25	0,76
CWI 16-6	6300	105	21	20	104	37	32	28	1,41

Ganci ad occhio HSWI

HSWI Eye sling hook

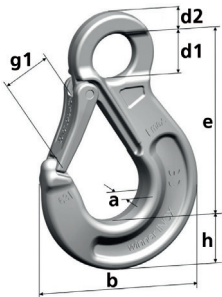

Tipo Type	Portata WLL Kg	Dimensioni Dimensions							Peso Weight Kg
		a mm	b mm	d1 mm	d2 mm	e mm	g1 mm	h mm	
HSWI 5/6-6	900	14	67	21	8	84	22	20	0,25
HSWI 7/8-6	1600	20	98	27	13	112	32	29	0,70
HSWI 10-6	2500	28	115	37	15	133	39	33	1,35
HSWI 13-6	4250	35	147	48	18	172	51	43	2,60
HSWI 16-6	6300	44	182	55	24	213	66	51	4,80

Accorciatore VLWI

VLWI Shortener

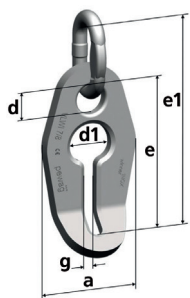

Tipo Type	Portata WLL Kg	Dimensioni Dimensions						Peso Weight Kg
		a mm	d mm	d1 mm	e mm	e1 mm	g mm	
VLWI 5/6-6	900	52	16	26	80	114	8	0,22
VLWI 7/8-6	1600	68	22	34	111	156	11	0,57
VLWI 10-6	2500	86	27	40	133	183	12	1,06
VLWI 13-6	4250	108	32	52	169	242	16	2,20
VLWI 16-6	6300	134	38	64	204	284	20	4,16



Applicazione corretta
Correct application



Applicazione corretta
Correct application



Applicazione corretta
Correct application

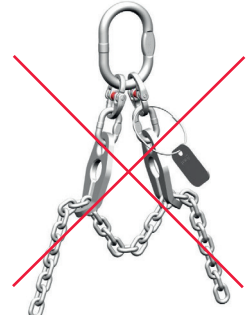

Applicazione sbagliata
Wrong application

Catene e accessori di acciaio inossidabile

Stainless steel chain and accessory system

Grillo SSWI

SSWI Safety shackle

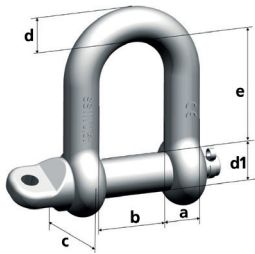

Tipo Type	Portata WLL Kg	Dimensioni Dimensions						Peso Weight Kg
		a mm	b mm	c mm	d mm	d1 mm	e mm	
SSWI 0,4 t-S	400	8	21,5	18	8	9	35	0,07
SSWI 0,5 t-S	500	8	18	18	8	9	33	0,07
SSWI 1,25 t-S	1250	12	25	25	12	13	40	0,22
SSWI 2 t-S	2000	16	32	32	16	17	60	0,52
SSWI 3,2 t-S	3200	19	41	47	19	21	78	0,80
SSWI 5 t-S	5000	25	56	60	25	29	109	2,2
SSWI 26	13000	34	76	75	34	38	152	7

Gancio girevole CSEI

CSEI Stainless steel swivel hook

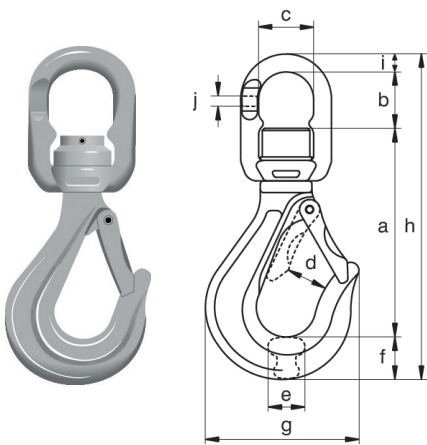

Tipo Type	Portata WLL Kg	Dimensioni Dimensions										Peso Weight Kg
		a mm	b mm	c mm	d mm	e mm	f mm	g mm	h mm	i mm	j mm	
CSEI 07	700	100	33	32	27	15	19	73	164	12	6	0,55
CSEI 1,2	1200	126	39	37	30	20	22	85	200	14	8	1
CSEI 1,6	1600	159	47	48	33	24	29	106	250	16	11	1,9
CSEI 2,7	2700	189	59	58	36	32	39	133	307	21	14	3,4

- Girevole su rondella di acciaio inossidabile.
Non di produzione Pewag.
- Equipped with a stainless steel washer.
Not a Pewag product.

Catene e accessori di acciaio inossidabile

Stainless steel chain and accessory system

Sicurezza SFGWI

SFGWI Safety latch

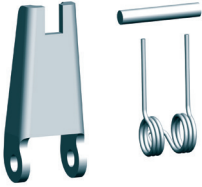

Tipo
Type

SFGWI 5
SFGWI 7
SFGWI 10
SFGWI 13
SFGWI 16

Per gancio tipo G5

For hook G5 type

HSWI 5 G5 marcato HSK 5
HSWI 7 G5 marcato HSK 7
HSWI 10 G5 marcato HSK 10
HSWI 13 G5 marcato HSK 13
HSWI 16 G5 marcato HSK 16



Tipo
Type

SFGWI 5/6-6
SFGWI 7/8-6
SFGWI 10-6
SFGWI 13-6
SFGWI 16-6

Per gancio tipo G6

For hook G6 type

HSWI 5/6-6 G6 marcato HSWI 5/6-6
HSWI 7/8-6 G6 marcato HSWI 7/8-6
HSWI 10-6 G6 marcato HSWI 10-6
HSWI 13-6 G6 marcato HSWI 13-6
HSWI 16-6 G6 marcato HSWI 16-6

Perni e bussole CBHWI per maglie di giunzione

CBHWI Bolt and safety set for connecting link

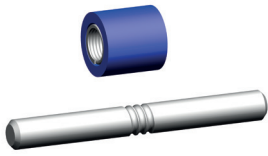

Tipo
Type

CBHWI 5-6
CBHWI 6-6
CBHWI 7/8-6
CBHWI 10-6
CBHWI 13-6
CBHWI 16-6

Per maglia di giunzione G6 tipo

For connecting link type G6

CWI 5-6
CWI 6-6
CWI 7-6 + CWI 8
CWI 10-6
CWI 13-6
CWI 16-6



Catene e accessori di acciaio inossidabile - Grado 6

Stainless steel chain and accessory system in G6

PORTATA DELLE IMBRAGATURE

LOAD CAPACITIES

PORTATA DELLE IMBRAGATURE

LOAD CAPACITIES

Coefficiente di sicurezza 4 Safety factor 4	1 braccio 1 leg		2 bracci 2 legs				3 e 4 bracci 3 and 4 legs		Anello continuo Endless chain sling	Imbragatura a canestro Loop chains				Imbragatura a U U-Shape	
Angolo β Angle β	-	-	0°-45°	45°-60°	0°-45°	45°-60°	0°-45°	45°-60°	-	0°-45°	45°-60°	0°-45°	45°-60°	-	
Fattore di carico Load factor	1	0,8	1,4	1	1,12	0,8	2,1	1,5	1,6	1,4	1	2,1	1,5	2	
Catena tipo Chain type	d	Portata Kg WLL Kg													
C-WOX 6-6	6	900	720	1250	900	1000	720	1850	1350	1400	1250	900	1850	1350	1800
C-WOX 7-6	7	1250	1000	1750	1250	1400	1000	2600	1850	2000	1750	1250	2600	1850	2500
C-WOX 8-6	8	1600	1280	2200	1600	1800	1280	3350	2400	2500	2220	1600	3350	2400	3200
C-WOX 10-6	10	2500	2000	3500	2500	2800	2000	5250	3750	4000	3500	2500	5250	3750	5000
C-WOX 13-6	13	4250	3400	5950	4250	4750	3400	8900	6350	6800	5950	4250	8900	6350	8500
C-WOX 16-6	16	6300	5040	8800	6300	7050	5040	13200	9400	10000	8800	6300	13200	9400	12600

LIMITAZIONI ALL'USO DELLE BRACHE

DEMANDING CONDITIONS

When the chains are exposed to severe conditions (e.g. high temperatures, asymmetric load distribution, edge loading, impact/shock loads) the maximum working load limit value must be reduced according to the table below. If chains are wound around support arms or other round-shaped loads, the diameter should be minimum 3 times the chain pitch. For smaller diameters, the lifting capacity of the chains must be reduced by 50%. The stainless steel slings G6 should not be used with temperatures over 350°C. For applications with higher temperatures, we will gladly advise you.

Quando le brache sono soggette a severe condizioni di impiego (es alte temperature, carichi asimmetrici, carico su spigoli, shock) i valori massimi di portata devono essere ridotti come indicato nella tabella che segue.

Se le brache vengono avvolte su dei perni o imbragano dei carichi di forma rotonda, il diametro degli stessi deve essere minimo 3 volte il passo della catena. In caso di diametri inferiori, la portata della braca deve essere ridotta del 50%.

Le brache di catena grado 6 non possono essere impiegate in presenza di temperature superiori a 350°C. In caso di necessità, consultare FAS SpA.

Temperatura Temperature	-40°C ÷ 350°C	-40°C ÷ 350°C	> 350°C
Fattore di carico Load factor	1	1	Non ammissibile Not permissible
Distribuzione asimmetrica del carico Asymmetric load distribution	Il carico massimo di lavoro dell'imbragatura deve essere ridotto di almeno un braccio. In caso di dubbi, considerare la portata di un singolo braccio di catena. The WLL has to be reduced by at least 1 leg. In case of dubt only consider 1 leg as load-bearing.		
Sollevamento con catena a contatto con spigoli Edge load	 R > 2 x Ø catena/chain	 R > Ø catena/chain	 R < Ø catena/chain
Fattore di carico Load factor	1	0,7	0,5
Shock	Shock leggero Slight shock	Shock medio Medium shock	Shock pesante Heavy shock
Fattore di carico Load factor	1	0,7	Non ammissibile Not permissible

Catene e accessori di acciaio inossidabile - Grado 6

Stainless steel chain and accessory system in G6

Catena C-WOX

C-WOX Chain

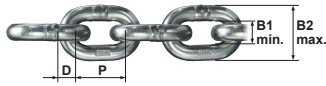

Tipo Type	Diametro nominale Nominal diameter	Passo Pitch	Larghezza interna B1 min Inside width B1 min	Larghezza esterna B2 max Outside width B2 max	Portata WLL	Carico di rottura Breaking force	Peso Weight
	D mm	mm	mm	mm	Kg	kN	Kg/m
C-WOX 6	6	18	7,8	22,2	900	35,4	0,8
C-WOX 7	7	21	9,1	25,9	1250	49,1	1,1
C-WOX 8	8	24	10,4	29,6	1600	62,8	1,4
C-WOX 10	10	30	13	37	2500	98,1	2,25
C-WOX 13	13	39	16,9	48,1	4250	166,8	3,75
C-WOX 16	16	48	20,8	59,2	6300	247,3	6,6

Campanella semplice C-AWI

C-AWI Master link

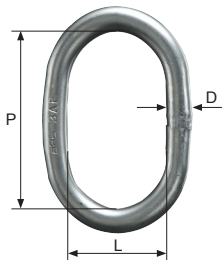

Tipo Type	Portata 0°-45° WLL 0°-45°	Dimensioni Dimensions			Peso Weight	Campanella per catena Ø Master link for chain Ø	
		D mm	P mm	L mm		1 braccio 1 leg	2 bracci 2 legs
C-AWI 0706	1600	13	110	60	0,34	6 / 7	6
C-AWI 08	1600	13	110	60	0,34	8	-
C-AWI 1008	2600	16	110	60	0,53	10	7 / 8
C-AWI 1310	4250	18	135	75	0,8	13	10
C-AWI 1613	6300	22	160	90	1,5	16	13
C-AWI 1816	8900	26	180	100	2,3	-	16

Campanella tripla C-VWI

C-VWI Master link assembly

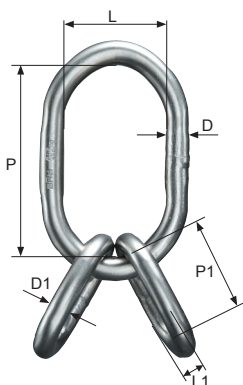

Tipo Type	Portata 0°-45° WLL 0°-45°	Dimensioni Dimensions						Peso Weight	Campanella per catena Ø Master link for chain Ø
		D mm	P mm	L mm	D1 mm	P1 mm	L1 mm		
C-VWI 6	1700	13	110	60	10	44	20	0,52	3/4 bracci 3/4 legs
C-VWI 7	2600	16	110	60	13	54	25	0,97	6
C-VWI 8	3350	18	135	75	16	70	34	1,6	7
C-VWI 10	5250	22	160	90	18	85	40	2,76	8
C-VWI 13	8900	26	180	100	22	115	50	4,45	10
C-VWI 16	13200	32	200	110	26	140	65	7,55	13

Catene e accessori di acciaio inossidabile - Grado 6

Stainless steel chain and accessory system in G6

Maglia di giunzione C-CWI

C-CWI Connecting link

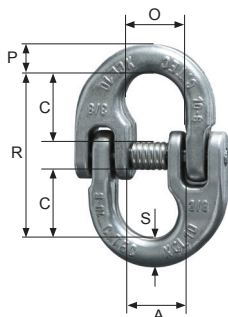

Tipo Type	Portata WLL Kg	Dimensioni Dimensions						Peso Weight Kg	Per catena Ø For chain Ø mm
		A mm	C mm	O mm	R mm	P mm	S mm		
C-CWI 6	900	14	18	18	45	8	7,5	0,52	6
C-CWI 7	1250	18	20	20,5	50,5	10,2	9	0,97	7
C-CWI 8	1600	19	25,5	23,5	62	11,5	10	1,6	8
C-CWI 10	2500	24	30	27,5	72	12,6	12,6	2,76	10
C-CWI 13	4250	28	36	33,5	87,5	19	16,7	4,45	13
C-CWI 16	6300	34,5	40,5	39,5	105	20,6	20,6	7,55	16

Gancio ad occhio C-HSWI

C-HSWI Eye sling hook

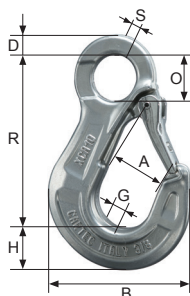

Tipo Type	Portata WLL Kg	Dimensioni Dimensions								Peso Weight Kg	Per catena Ø For chain Ø mm
		A mm	B mm	D mm	G mm	H mm	O mm	R mm	S mm		
C-HSWI 5/6	900	23	72	8	13,5	21	21	90	8	0,25	5 / 6
C-HSWI 7/8	1600	32	103	13	19,5	29	27	118	13	0,7	7 / 8
C-HSWI 10	2500	39	120	15	27	33	37	140	15	1,3	10
C-HSWI 13	4250	51	155	18	35	46	48	182	18	2,6	13
C-HSWI 16	6300	66	183	24	44	51	55	213	24	4,8	16

Gancio a perno C-KHSWI

C-KHSWI Clevis sling hook

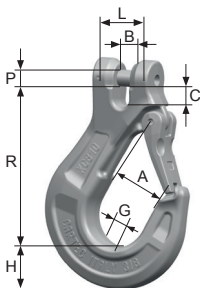

Tipo Type	Portata WLL Kg	Dimensioni Dimensions							Peso Weight Kg	Per catena Ø For chain Ø mm
		A mm	B mm	C mm	G mm	H mm	R mm	PxL mm		
C-KHSWI 6	900	23	7,2	8,5	13,5	21	81	8x19,5	0,35	6
C-KHSWI 7	1250	32	9,5	12	19,5	29	112	8x22,5	0,8	7
C-KHSWI 8	1600	32	9,5	11	19,5	29	111	10x22,5	0,85	8
C-KHSWI 10	2500	39	12	15	27	33	122	13x31,5	1,4	10

Gancio accorciatore C-VLWI

C-VLWI Clevis grab hook

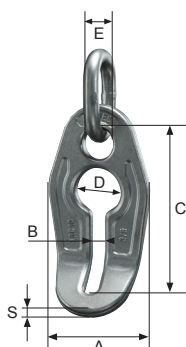

Tipo Type	Portata WLL Kg	Dimensioni Dimensions						Peso Weight Kg	Per catena Ø For chain Ø mm
		A mm	B mm	C mm	D mm	E mm	S mm		
C-VLWI 5/6	900	55	8	81	26	16	8,5	0,2	5 / 6
C-VLWI 7/8	1600	71	11	110	34	22	10,5	0,55	7 / 8
C-VLWI 10	2500	90	12	135	40	26	13	1,05	10
C-VLWI 13	4250	112	17	170	52	32	16,5	2,2	13
C-VLWI 16	6300	135	20,5	202	64	38	20	4,1	16

Catene e accessori di acciaio inossidabile - Grado 6

Stainless steel chain and accessory system in G6

Grillo C-SSWI

C-SSWI Connecting link

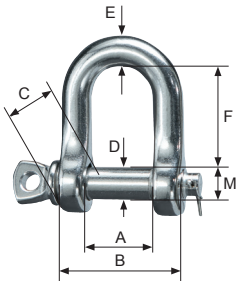

Tipo Type	Portata WLL Kg	Dimensioni Dimensions							M	Peso Weight Kg
		A mm	B mm	C mm	D mm	E mm	F mm			
C-SSWI 0,5	500	18	34	18	9	8	33	M 10	0,07	
C-SSWI 1,25	1250	25	49	25	13	12	40	M 14	0,2	
C-SSWI 2	2000	32	64	32	17	16	60	M 18	0,5	
C-SSWI 3,2	3200	41	79	47	21	19	78	M 22	0,8	
C-SSWI 5	5000	56	106	60	29	25	109	M 30	2,2	
C-SSWI 13	13000	76	144	75	38	34	152	M 39	7,0	

Sicurezza C-SFGWI

C-SFGWI Safety catch set

Tipo Type	Accessori d'utilizzo Accessories of use	
C-SFGWI 5/6	C-HSWI 6	C-KHSWI 6
C-SFGWI 7/8	C-HSWI 7/8	C-KHSWI 7 / C-KHSWI 8
C-SFGWI 10	C-HSWI 10	C-KHSWI 10
C-SFGWI 13	C-HSWI 13	
C-SFGWI 16	C-HSWI 16	

TARGA DI ACCIAIO INOSSIDABILE

ID IDENTIFICATION TAG

Undeattachable stainless steel identification tag and quick release fastener, corrosion resistant to solvents, acids, caustics and their vapours.

Pre stamped year dates make it immediately apparent when the last inspection took place; it is only necessary to stamp the month of the periodic inspection.

Targa e cordino di acciaio inossidabile resistenti a solventi, acidi, soda e ai vapori.

Incisi sul retro in modo progressivo gli anni per poter vedere facilmente quando è stata ispezionata la braca; è sufficiente punzonare il mese in cui è avvenuta l'ispezione.

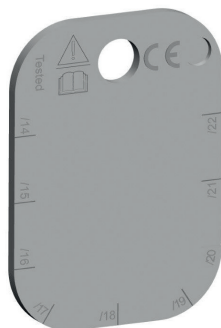

Tipo PCWI

PCWI type

From 200 kg to max. 12.000 kg load capacity. PCWI pump chains type in welded systems are, because of their construction and range of components, suitable for submersible pumps and breathers in the water and waste water area. Every chain sling is tested and serialized with identification tag and a test certificate will be added.

Master links at the beginning, in segment distances and at the end allow the users to lift up, to lower or lock the pump chain in steps

Additional to standard design, customer-made variations are possible:

- Two legged system with "Y" for pumps equipped with 2 eye screws
- Alternative end fittings, like eye hooks, joining links or shackles
- Available with additional stabilization chain
- Variational of standard segment length, also in different sections possible
- Special constructions
- Stainless steel hoist chains for pump stations by request

For joining pumps and pump chains, we suggest safety shackles type SSWI.

I tiranti a catena di acciaio inossidabile PCWI sono ideati per la movimentazione di pompe immerse in acque reflue.

Ogni tirante viene testato e identificato con numero di matricola inciso su targa inossidabile.

Le campanelle posizionate all'inizio, alla fine e lungo il tirante permettono all'operatore di sollevare, calare o fissare il tirante in differenti posizioni.

Nella tabella sotto vengono riportati i tiranti disponibili nella versione classica con campanelle. È possibile realizzare tiranti su specifica del cliente:

- tiranti con due bracci inferiori a Y per pompe con due punti di presa
- Accessori terminali alternativi quali ganci, grilli o maglie diverse
- Disponibili con catena di stabilizzazione aggiuntiva
- Passi campanelle diversi dallo standard

Per il collegamento del tirante alla pompa consigliamo i grilli SSWI.

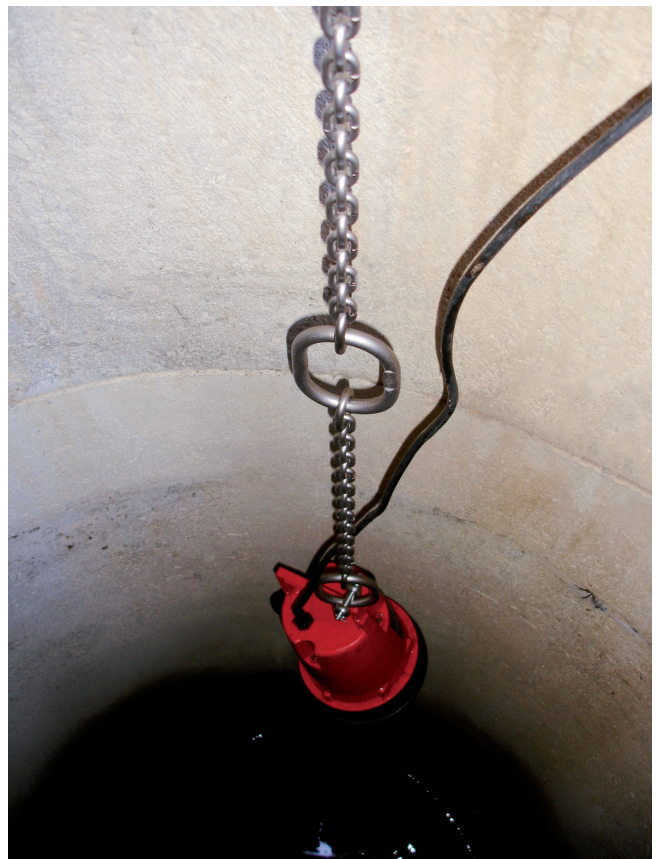
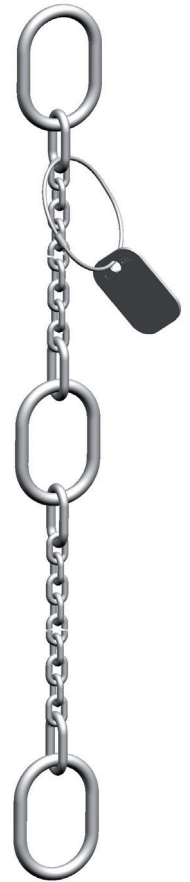

DATI TECNICI TECHNICAL DATA

Tipo Type	Portata WLL Kg	Campanella tipo Master link AWI	Dimensioni campanella Dimensions AWI mm	Maglia di transizione tipo Transition link BWI	Dimensioni maglia di transizione Dimensions BWI mm	Catena tipo Chain type WOX	Maglie di catena che compongono SL* SL* number of links	Lunghezza segmento SL* Segment length SL* mm	Lunghezza campanelle Length of master links/end links mm	Peso SL* Weight SL* Kg
PCWI 4/320	320	AWI 6	6x60x35	-	-	WOX 4x12	77	984	60	0,39
PCWI 4/400	400	AWI 8	8x60x35	BWI 5	5x26x13	WOX 4x12	73	988	60	0,43
PCWI 5/560	560	AWI 8	8x60x35	BWI 7	7x36x16	WOX 5x15	53	943	60	0,62
PCWI 5/630	630	AWI 10	10x80x50	BWI 7	7x36x16	WOX 5x15	53	963	80	0,68
PCWI 6	850	AWI 10	10x80x50	BWI 7	7x36x16	WOX 6x18	47	998	80	0,90
PCWI 7	1250	AWI 13	13x110x60	BWI 9	9x44x20	WOX 7x21	37	975	110	1,35
PCWI 8	1600	AWI 13	13x110x60	BWI 10	10x44x20	WOX 8x24	33	990	110	1,70
PCWI 10	2500	AWI 16	16x110x60	BWI 13	13x54x25	WOX 10x30	25	968	110	2,60
PCWI 13	3500	AWI 18	18x135x75	BWI 16	17x70x34	WOX 13x39	19	1016	160	4,50
PCWI 16	6300	AWI 22	23x160x90	BWI 20	20x85x40	WOX 16x48	15	1050	135	8,00
PCWI 20	8000	AWI 26	27x180x100	BWI 22	23x115x50	WOX 20x60	27	2030	180	21,00
PCWI 26	12000	AWI 45	45x340x180	BWI 32	32x150x70	WOX 26x78	19	2122	340	43,20

SL*

Nella tabella sopra vengono indicate le lunghezze standard SL di ogni singolo segmento. Al momento dell'ordine, per favore indicare il numero totale di segmenti necessari.

La lunghezza totale del tirante sarà uguale alla somma dei segmenti SL più la lunghezza del componente terminale.

When ordering pump chains, please request desired total length of chain or number of segments and specify the kind of endfitting (i.e. AWI master link). Total length conforms a multiple of segment length plus pitch of end fitting.

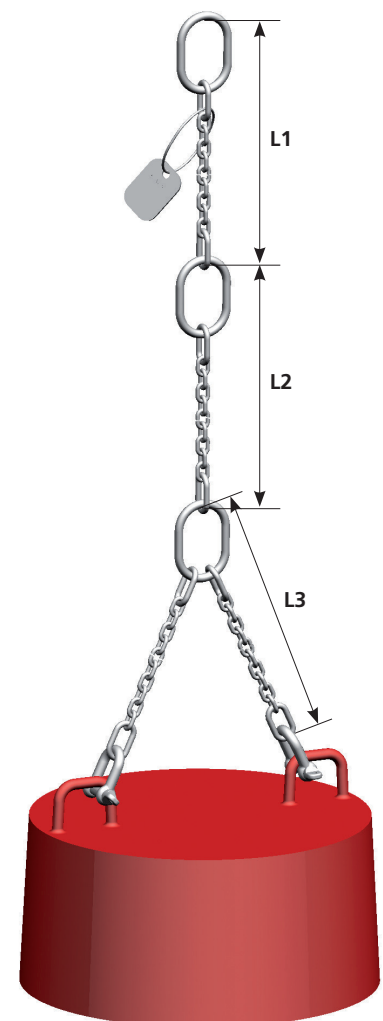
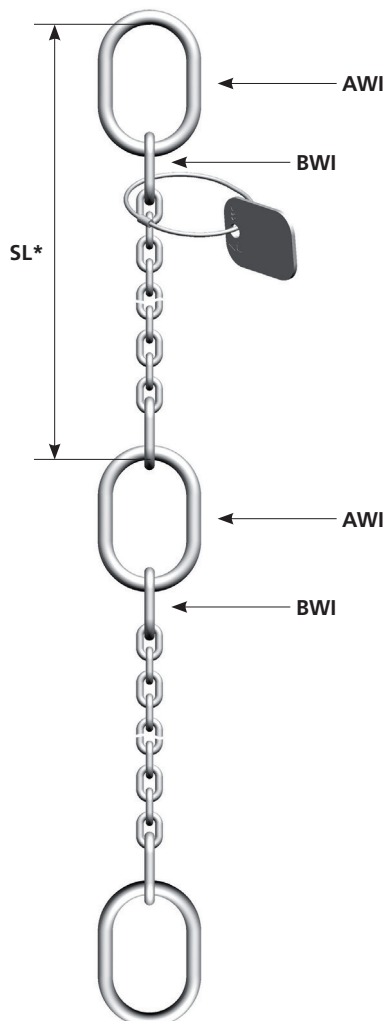

Imbragature speciali per impianti galvanici

Special chain slings for hot galvanizing plant

CARATTERISTICHE SPECIFICATION

Galvanizing plants use various types of sling chains for lifting and transporting parts to be galvanized and for adding zinc-ingots.

Chains, particularly those used during the galvanizing process, are subject to extraordinarily high stress:

1. they are heated up to approx. 475°C in the galvanizing bath.
2. they are subjected to zinc corrosion.
3. the hydrogen that develops during the repeated work cycles of "galvanizing – pickling – galvanizing" in the galvanizing bath has a considerable effect on the chains.

The absorption of hydrogen causes the dreaded stress corrosion cracking which results in component breakage without any signs of deformation or any other previous warning signals. In the case of sling chains, such failure would have dramatic consequences. With pewag's special sling chains for hot galvanizing plants you have this problem under control!

In galvanizing plants, the chains are used in diluted sulfuric or hydrochloric acid of a concentration of 15% at approx. 20-30°C bath temperature. The use of pewag chains offers further important advantage compared to ordinary chains of grade 2 acc. to BGR 150:

- Due to the higher strength (quality grade 4 according to EN 818-5), the ratio of load capacity and mass is improved by a factor of 2.6
- The surface of the chains and thus the undesired drag-out is reduced by nearly 30%.

At high temperature, pewag's special sling chains for hot galvanizing plants achieve a 25% higher minimum breaking force than those demanded in EN 818-5 or EN 818-6, which means 25% more safety for the user.

Gli impianti di zincatura utilizzano vari tipi di catene d'imbracatura per sollevare e trasportare parti che devono essere zincate e per aggiungere barre di zinco.

Le catene, in modo particolare quelle utilizzate durante il processo di zincatura, sono soggette a sforzi straordinariamente elevati:

1. Sono riscaldate fino a circa 475°C nel bagno di zincatura.
2. Corrosione dovuta allo zinco.
3. L'idrogeno, che si sviluppa durante i cicli di lavoro ripetuti di "zincatura - decapaggio - zincatura" nel bagno galvanico, ha un effetto considerevole sulle catene.

L'assorbimento di idrogeno causa la temuta rottura per corrosione sotto sforzo, quest'ultima provoca la spaccatura del componente senza segni di deformazione o altri precedenti segnali di avvertimento. Nel caso delle catene d'imbracatura, tale conseguenza potrebbe provocare effetti drammatici.

Con le speciali catene di imbracatura Pewag per impianti di galvanizzazione a caldo questo problema è sotto controllo!

Negli impianti di zincatura, le catene sono utilizzate in acido solforico o cloridrico diluito per una concentrazione del 15% circa ad una temperatura del bagno pari a 20-30°C.

L'uso delle catene Pewag offre importanti vantaggi paragonati alle catene comuni di grado 2, in relazione a BGR 150:

- Grazie alla migliore qualità dell'acciaio (qualità di grado 4 in relazione a EN 818-5), il rapporto portata nominale e massa catena è 2,6.
- La superficie delle catene e l'indesiderata fuoriuscita di zinco si riducono di circa 30%.

A elevate temperature, le speciali catene d'imbracatura Pewag per impianti di zincatura a caldo raggiungono un carico minimo di rottura superiore del 25% rispetto a quello richiesto dalle norme EN 818-5 o EN 818-6, ciò significa il 25% in più di sicurezza per l'utilizzatore.

PRODUZIONE PRODUCTION

All sling chains are produced in all welded design pursuant to EN 818-5 and afterwards subjected to a special treatment to increase the resistance to stress corrosion cracking.

Tutte le catene d'imbracatura sono prodotte seguendo progetti di saldatura conformi alla norma EN 818-5 e, in seguito, sottoposte a speciale trattamento per migliorare la resistenza alla rottura per corrosione da sforzo.

MARCATURA MARKING

A rectangular tag with "for hot galvanizing" stamped is used for identification.

Per l'identificazione viene fornita una targhetta rettangolare con numero di matricola, portata, la dicitura stampata al suo interno: "for hot galvanizing" (per impianti di zincatura a caldo) e la temperatura max di utilizzo (475°C).

USO USE

Pewag's special chain slings for hot galvanizing plants have been developed to meet the demands of the repeated pickling and galvanizing cycles. They can be used in sulfuric or hydrochloric acid baths up to a maximum concentration of 15% and a temperature of up to 30°C. These chains are not suitable for pickling plants that use baths of higher concentration.

Le catene d'imbracatura speciali Pewag per impianti di zincatura a caldo sono state sviluppate per incontrare le esigenze dei cicli ripetuti di decapaggio e zincatura. Esse possono essere utilizzate in bagni di acido solforico o cloridrico fino a una concentrazione massima del 15% a temperatura fino a 30°C. Queste catene non sono adatte per impianti di decapaggio che utilizzano bagni con concentrazioni più elevate.

SOSTITUZIONE DOVUTA ALLO STATO DI USURA REPLACEMENT STATE OF WEAR

The provisions of EN 818-6 apply particularly for replacement state of wear.

Per le sostituzioni dovute allo stato dell'usura, seguire le disposizioni della norma EN 818-6.

Imbragature speciali per impianti galvanici

Special chain slings for hot galvanizing plant

IMBRAGATURE NON IDONEE PER IMPIANTI DI ZINCATURA A CALDO

IMPERMISSIBLE CHAIN SLINGS IN HOT GALVANIZING PLANTS

According to EN 818-6 chain slings of grade 8 should not be used either immersed in acid solutions or exposed to acid fumes. Attention is drawn to the fact that certain production processes involve acid solutions and fumes and in these circumstances the manufacturer's advice should be sought. Furthermore it shall be avoided chains slings with pins and jointing, where corrosives can accumulate and concentrate. It is recommended to use welded chain slings.

In accordo a EN 818-6 le brache di grado 8 non devono essere utilizzate immerse in soluzioni acide o esposte a fumi acidi. Bisogna prestare attenzione al fatto che certi processi produttivi utilizzano soluzioni acide e in tali circostanze è necessario domandare il parere del costruttore. Inoltre si sconsiglia l'impiego di brache costruite secondo il metodo classico con giunzioni e perni. In questi casi l'acido può causare seri danni senza preavviso. Si raccomanda l'utilizzo di brache con accessori saldati.

LIMITAZIONI ALL'USO DELLE BRACHE

DEMANDING CONDITIONS

Quando la catena viene avvolta su un perno o intorno al carico, il diametro dello stesso deve essere almeno 3 volte il passo della catena. In caso contrario, la portata della braca deve essere ridotta del 50%.

When lifting with chains on lugs or on round loads, it is recommended to use a lug diameter of at least 3 x the pitch of the chain. If this is not a case, the working load limit must be reduced by 50%.

Temperatura Temperature	-40°C ÷ 475°C		
Fattore di carico Load factor	1		
Distribuzione asimmetrica del carico Asymmetric load distribution	<p>La portata della braca deve essere diminuita di un braccio. Nel caso di brache a 3-4 bracci, la portata sarà quella di una braca a 2 bracci della catena corrispondente. Nel caso di brache a 2 bracci, la portata sarà quella della braca ad un braccio. Se la distribuzione del carico non è chiara, considerare sempre la portata della braca ad 1 braccio.</p> <p>The capacity of the sling should be decreased to a leg. In the case of 3 - 4 legs slings, the capacity will be as a 2 legs sling of the corresponding chain. In the case of 2 legs slings, the capacity will be of 1 leg sling. If the distribution of the load is not clear, always consider the capacity of 1 leg sling.</p>		
Sollevarmento con catena a contatto con spigoli Edge load	<p>R > 2 x Ø catena/chain</p>	<p>R > Ø catena/chain</p>	<p>R < Ø catena/chain</p>
Fattore di carico Load factor	1	0,7	0,5
Shock	Shock leggero Slight shock	Shock medio Medium shock	Shock pesante Heavy shock
Fattore di carico Load factor	1	0,7	Non ammissibile Not permissible

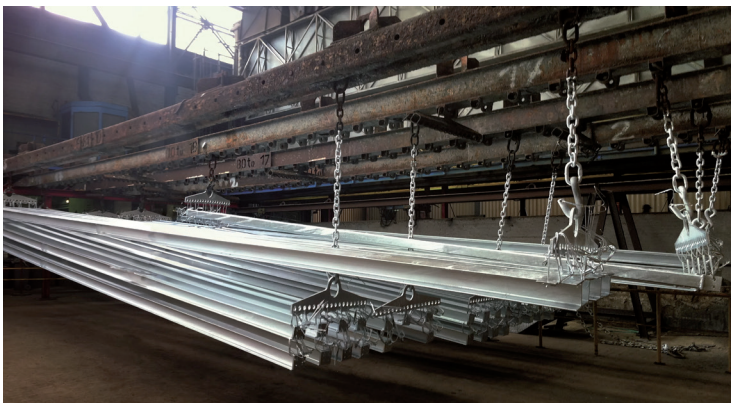

Imbragature speciali per impianti galvanici

Special chain slings for hot galvanizing plant

PORTATA DELLE IMBRAGATURE

LOAD CAPACITIES

Coefficiente di sicurezza 4 Safety factor 4	1 braccio 1 leg		2 bracci 2 legs				3 e 4 bracci 3 and 4 legs		Anello continuo Endless chain sling	
Angolo β Angle β	-	-	0° - 45°	45° - 60°	0° - 45°	45° - 60°	0° - 45°	45° - 60°	-	
Fattore di carico Load factor	1	0,8	1,4	1	1,12	0,8	2,1	1,5	1,6	
Catena tipo Chain type	d	Portata Kg WLL Kg								
KWF 8	8	500	400	700	500	560	400	1060	750	800
KWF 10	10	800	625	1120	800	850	625	1675	1180	1250
KWF 13	13	1325	1060	1875	1325	1500	1060	2800	2000	2125
KWF 16	16	2000	1575	2800	2000	2250	1575	4250	3000	3150
KWF 20	20	3150	2500	4250	3150	3550	2500	6600	4750	5000
KWF 22	22	3750	3000	5300	3750	4240	3000	8000	5600	5900

Catena KWF - KWF/HT

KWF - KWF/HT Chain

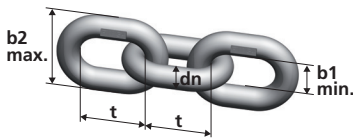

Codice Code	Codice Code	Diametro nominale Nominal diameter	Lunghezza standard Standard delivery length	Passo Pitch	Larghezza interna Inside width	Larghezza esterna Outside width	Portata WLL	Carico di rottura Breaking force	Peso Weight
KWF	KWF/HT	dn mm	m	t mm	b1 min mm	b2 max mm	Kg	kN	Kg/m
KWF 8	-	8	50	24	11	29	500	33,3	1,41
KWF 10	KWF/HT 10	10	50	30	14	36	800	53,2	2,20
KWF 13	KWF/HT 13	13	50	39	18	47	1325	88,1	3,71
KWF 16	KWF/HT 16	16	25	48	22	58	2000	133	5,62
KWF 20	-	20	25	60	27	70	3150	209	8,76
KWF 22	-	22	25	66	30	79	3750	251	11,18

Campanella semplice AWF

AWF Master link

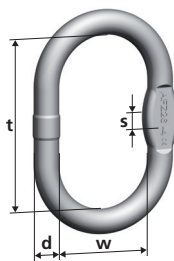

Codice Code	Portata 0°-45° WLL 0°-45° Kg	Idonea per ganci DIN 15401 Can be used up to single hook acc. to DIN 15401 n°	Dimensioni Dimensions				Peso Weight Kg	Campanella per catena \emptyset Master link for chain \emptyset	
			d mm	t mm	w mm	s mm		1 br./leg	2 br./leg
AWF 16	500	2,5	16	110	60	14	0,53	8	-
AWF 18	800	5	19	135	75	14	0,86	10	8
AWF 22	1325	6	23	160	90	17	1,60	13	10
AWF 26	2000	8	27	180	100	20	2,46	16	13
AWF 32	3150	10	33	200	110	26	4,14	20	16
AWF 36	4250	16	36	260	140	-	6,22	22	20
AWF 45	5900	25	45	340	180	-	12,82	-	22
AWF 50	8000	32	50	350	190	-	16,55	-	-

Gancio ad occhio HWF

HWF Eye sling hook

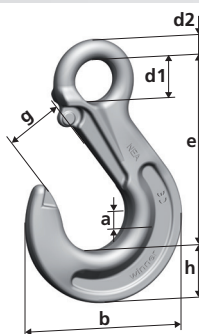

Codice Code	Portata WLL Kg	Dimensioni Dimensions							Peso Weight Kg
		a mm	b mm	d1 mm	d2 mm	e mm	g mm	h mm	
HWF 8	500	19	88	25	11	106	32	27	0,50
HWF 10	800	26	109	34	16	131	40	33	1,10
HWF 13	1325	33	134	43	19	164	48	44	2,20
HWF 16	2000	40	155	50	25	183	56	50	3,50
HWF 20	3150	48	178	55	27	205	62	55	5,80
HWF 22	3750	50	196	60	29	225	72	62	8,00

Imbragature speciali per impianti galvanici

Special chain slings for hot galvanizing plant

Catene KWF - Per decapaggio e zincatura

KWF chain slings - For pickling and galvanizing

When the slings are used to zinc the suspended load, we recommend to use the KWF chain slings. KWF slings can be used for the complete cycle pickling-galvanizing.

Quando le brache vengono utilizzate per immergere il materiale da zincare nel bagno galvanico, raccomandiamo l'impiego di brache tipo KWF. Queste brache sono idonee anche per il decapaggio.

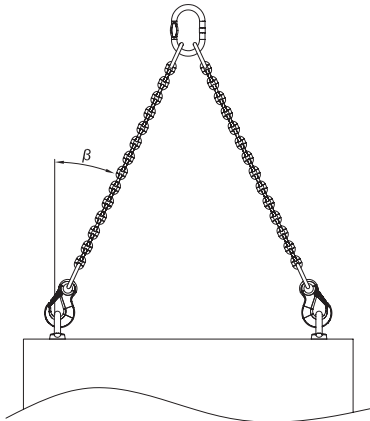

Catene KWF/HT - Per fusione pani di zinco

KWF/HT chain slings - To melt the ingots

When the chain slings are used in zinc bath to melt the ingots, they are as long in the bath with a temperature of about 480°C.

For use, the slings are wrapped around the zinc ingots, or through the hole of a big zinc ingot and they are continuously stressed with a further rapid abrasion of the chain.

The KWF/HT chain slings are specially heat treated compared to the standard KWF slings, and optimized for reduced abrasion in the zinc bath.



Quando le catene vengono utilizzate per sciogliere i pani di zinco, rimangono immerse nel bagno galvanico per lungo tempo ad una temperatura di circa 480°.

Inoltre, per questo impiego, le catene vengono avvolte intorno ai pani di zinco, o attraverso un foro nei pani più grandi, e sono soggette a continue sollecitazioni che portano ad una rapida abrasione della catena.

Le catene KWF/HT subiscono un trattamento superficiale diverso dalle catene KWF, riducendo il fenomeno dell'abrasione e garantendo ottime performances.

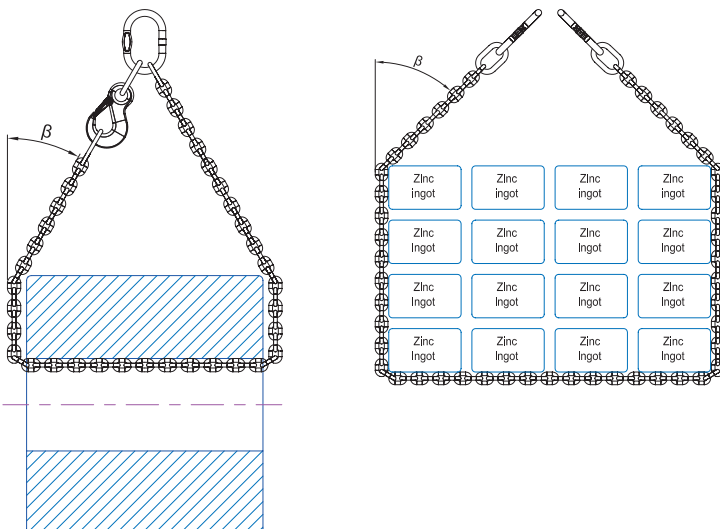
Tipo di utilizzo brache KWF/HT
Typical kind of use KWF/HT chain slings



Coefficiente di sicurezza 4 Safety factor 4	1 braccio 1 leg	2 bracci 2 legs
		
Angolo β Angle β	-	0° - 45°
Fattore di carico Load factor	1	1
Catena tipo Chain type	Portata Kg WLL Kg	
KWF/HT 10	10	800
KWF/HT 13	13	1325
KWF/HT 16	16	2000